

Panasonic®

Advanced Hybrid System Operating Manual

Model No. **KX-TA824**



Thank you for purchasing a Panasonic Advanced Hybrid System.
Please read this manual carefully before using this product and save this manual for future use.

KX-TA824: Version 3.0

Document Version: 2007-04

Feature Highlights

1.3.7 Built-in Voice Message (BV)

Built-in Voice Message

You can set incoming calls to be forwarded to your personal message area to let callers leave voice messages when you cannot answer the phone.

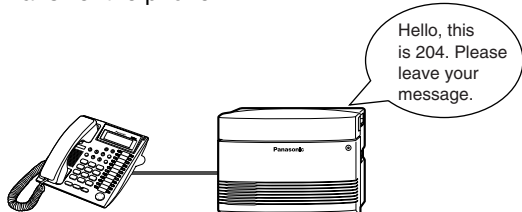

1.3.88 Voice Mail Integration

Voice Mail Integration

You can set your calls to be forwarded to a separate Voice Processing System (VPS) to let callers leave messages in your mailbox when you cannot answer the phone.

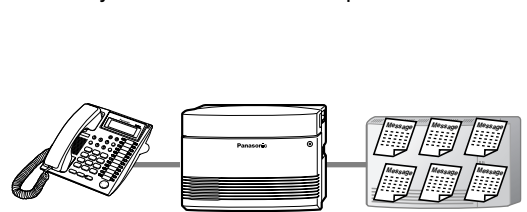

1.3.57 Local Carrier-based Voice Mail Service

Local Carrier-based Voice Mail Service

You can receive remote voice mail service from your telephone company to record caller messages when you cannot answer the phone.

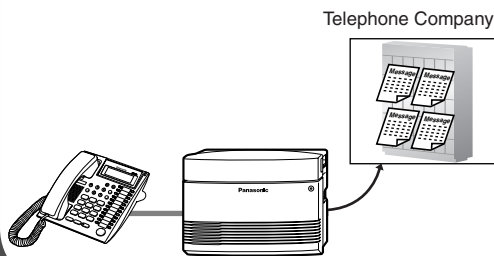

1.1.1 Before Operating a Telephone

Easy Operation

A Panasonic telephone that is equipped with a Navigator Key and a display helps you to access various features easily. The Message/Ringer lamp (if equipped) informs you of any calls or messages waiting.



Navigator Key

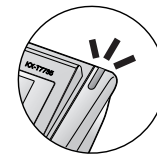

Message/Ringer Lamp

1.1.1 Before Operating a Telephone

Advanced Hybrid System

This PBX supports the connection of Panasonic proprietary telephones (PTs), Direct Station Selection (DSS) Consoles, and single line devices such as single line telephones (SLTs), fax machines, wireless SLTs, and data terminals.

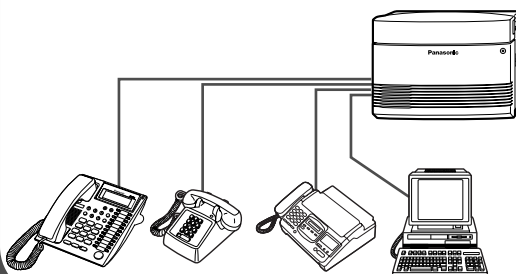

1.3.34 Direct Inward System Access (DISA)

3-level Automated Attendant

A caller can be directed to the desired party simply by pressing a single-digit number as directed by the 3-level DISA outgoing messages (OGMs).

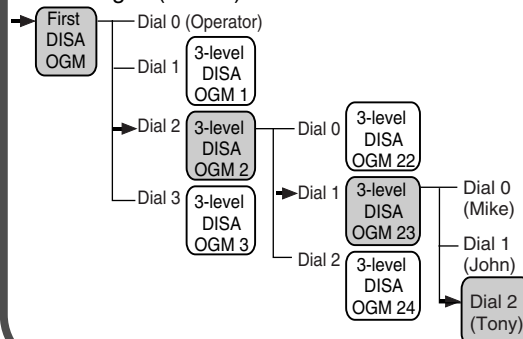

Wireless Proprietary Telephones

This PBX supports wireless proprietary telephones (PTs). These phones provide system features that make them superior to standard cordless telephones.

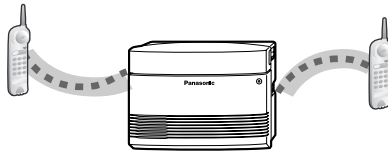

For more details, consult your dealer.

In this manual,

- Proprietary Telephone is abbreviated as "PT"^{*1}.
Single Line Telephone is abbreviated as "SLT".
Proprietary Telephone with a Display is abbreviated as "Display PT".
- The following icons are used as hints and conditions throughout this manual.



Hints



Conditions

Important Notice

Prior to connection of this product, please verify that the intended operating environment is supported. Satisfactory performance cannot be guaranteed for the following:

- interoperability and compatibility with all devices and systems connected to this product
- proper operation and compatibility with services provided by telecommunications companies over connected networks

^{*1} In this manual, "proprietary telephone" ("PT") means an analog proprietary telephone (APT).

Important Information

WARNING

- THIS UNIT MAY ONLY BE INSTALLED AND SERVICED BY QUALIFIED SERVICE PERSONNEL.
- IF DAMAGE TO THE UNIT EXPOSES ANY INTERNAL PARTS, DISCONNECT THE POWER SUPPLY CORD IMMEDIATELY AND RETURN THE UNIT TO YOUR DEALER.
- UNPLUG THIS UNIT FROM THE AC OUTLET IF IT EMITS SMOKE, AN ABNORMAL SMELL OR MAKES UNUSUAL NOISE. THESE CONDITIONS CAN CAUSE FIRE OR ELECTRIC SHOCK. CONFIRM THAT SMOKE HAS STOPPED AND CONTACT AN AUTHORIZED PANASONIC FACTORY SERVICE CENTER.
- WHEN RELOCATING THE EQUIPMENT, FIRST DISCONNECT THE TELECOM CONNECTION BEFORE DISCONNECTING THE POWER CONNECTION. WHEN THE UNIT IS INSTALLED IN THE NEW LOCATION, RECONNECT THE POWER FIRST, AND THEN RECONNECT THE TELECOM CONNECTION.
- THIS UNIT IS EQUIPPED WITH A GROUNDING CONTACT PLUG. FOR SAFETY REASONS THIS PLUG MUST ONLY BE CONNECTED TO A GROUNDING CONTACT SOCKET THAT HAS BEEN INSTALLED ACCORDING TO APPLICABLE REGULATIONS.
- TO PREVENT POSSIBLE FIRE OR ELECTRIC SHOCK, DO NOT EXPOSE THIS PRODUCT TO RAIN OR MOISTURE.
- THE POWER SUPPLY CORD IS USED AS THE MAIN DISCONNECT DEVICE. ENSURE THAT THE AC OUTLET IS LOCATED NEAR THE EQUIPMENT AND IS EASILY ACCESSIBLE.
- TO PROTECT THIS UNIT FROM STATIC ELECTRICITY, DO NOT TOUCH ANY EXTERNAL CONNECTORS OF THE UNIT.

IMPORTANT SAFETY INSTRUCTIONS

When using your telephone equipment, basic safety precautions should always be followed to reduce the risk of fire, electric shock and injury to persons, including the following:

1. Read and understand all instructions.
2. Follow all warnings and instructions marked on the product.
3. Unplug the product from the wall outlet before cleaning. Do not use liquid cleaners or aerosol cleaners. Clean with a damp cloth.
4. Do not use this product near water, for example, near a bathtub, wash bowl, kitchen sink, or laundry tub, in a wet basement, or near a swimming pool.
5. Do not place the product on an unstable surface, as a fall may cause serious internal damage.
6. Slots and openings in the front, back and bottom of the cabinet are provided for ventilation; to protect it from overheating, these openings must not be blocked or covered. The openings should never be blocked by placing the product on a bed, sofa, rug, or other similar surface while in use. The product should never be placed near or over a radiator or other heat source. This product should not be placed in a sealed environment unless proper ventilation is provided.
7. The product should only be connected to the type of electrical power supply specified on the product label. If you are not sure of the type of power supply to your home, consult your dealer or local power company.
8. For safety purposes this unit is equipped with a grounded plug. If you do not have a grounded outlet, please have one installed. Do not bypass this safety feature by tampering with the plug.
9. Do not allow anything to rest on the power cord. Do not locate this product where the power cord may be stepped on or tripped on.
10. To reduce the risk of fire or electric shock, do not overload wall outlets and extension cords.
11. Do not insert objects of any kind into this product through its slots and openings, as they may touch dangerous voltage points or short out parts that could result in a risk of fire or electric shock. Never spill liquid of any kind on or in the product.
12. To reduce the risk of electric shock, do not disassemble this product. Only qualified personnel should service this product. Opening or removing covers may expose you to dangerous voltages or other risks. Incorrect reassembly can cause electric shock.
13. Unplug this product from the wall outlet and have it serviced by qualified service personnel in the following cases:
 - a) When the power supply cord or plug is damaged or frayed.
 - b) If liquid has been spilled into the product.
 - c) If the product has been exposed to rain or water.
 - d) If the product does not operate according to the operating instructions. Adjust only the controls that are explained in the operating instructions. Improper adjustment of other controls may result in damage and may require service by a qualified technician to restore the product to normal operation.
 - e) If the product has been dropped or the cabinet has been damaged.
 - f) If product performance deteriorates.
14. Avoid using wired telephones during an electrical storm. There is a remote risk of electric shock from lightning.
15. Do not use a telephone in the vicinity of a gas leak to report the leak.

SAVE THESE INSTRUCTIONS

Attention

- Keep the unit away from heating appliances and devices that generate electrical noise such as fluorescent lamps, motors, and televisions. These noise sources can interfere with the performance of the PBX.
- This unit should be kept free of dust, moisture, high temperature (more than 40 °C [104 °F]), and vibration, and should not be exposed to direct sunlight.
- If you are having problems making calls to outside destinations, follow this procedure to test the outside (CO) lines:

1. Disconnect the PBX from all outside (CO) lines.
2. Connect known working single line telephones (SLTs) to those outside (CO) lines.
3. Make a call to an external destination using those SLTs.

If a call cannot be carried out correctly, there may be a problem with the outside (CO) line that the SLT is connected to. Contact your telephone company.

If all SLTs operate properly, there may be a problem with your PBX. Do not reconnect the PBX to the outside (CO) lines until it has been serviced by an authorized Panasonic Factory Service Center.

- Wipe the unit with a soft cloth. Do not clean the unit with abrasive powders or with chemical agents such as benzene or thinner.
- When using a Panasonic proprietary telephone (PT), use only the correct Panasonic handset.

Notice for users in California

This product contains a CR coin cell lithium battery that contains perchlorate material—special handling may apply. See www.dtsc.ca.gov/hazardouswaste/perchlorate

When you ship the product

Carefully pack and send it prepaid, adequately insured and preferably in the original carton. Attach a postage-paid letter, detailing the symptom, to the outside of the carton. DO NOT send the product to the Executive or Regional Sales offices. They are NOT equipped to make repairs.

Product Service

Panasonic Factory Service Centers for this product are listed in the Service Center Directory. Consult your certified Panasonic dealer for detailed instructions.

For Future Reference

Please print, record, and retain the following information for future reference.

Note

The serial number of this product can be found on the label affixed to the unit. You should record the model number and the serial number of this unit as a permanent record of your purchase to aid in identification in the event of theft.

MODEL NO.	_____
SERIAL NO.	_____
DATE OF PURCHASE	_____
NAME OF DEALER	_____
DEALER'S ADDRESS	_____ _____ _____
DEALER'S TEL. NO.	_____

F.C.C. REQUIREMENTS AND RELEVANT INFORMATION

1. Notification to the Telephone Company

This equipment complies with Part 68 of the FCC rules and the requirements adopted by the ACTA. On the side of this equipment is a label that contains, among other information, a product identifier in the following format:

- US:AAAEQ##TXXXX

If requested, this number must be provided to the telephone company.

Installation must be performed by a qualified professional installer. If required, provide the telephone company with the following technical information:

- Telephone numbers to which the system will be connected
- Make: Panasonic
- Model: KX-TA824
- Certification No.: found on the side of the unit
- Ringer Equivalence No.: 0.4B
- Facility Interface Code: 02LS2
- Service Order Code: 9.0F
- Required Network Interface Jack: RJ11

2. Ringer Equivalence Number (REN)

The REN is used to determine the number of devices that may be connected to a telephone line. Excessive RENs on a telephone line may result in the devices not ringing in response to an incoming call. In most but not all areas, the sum of RENs should not exceed five (5.0). To be certain of the number of devices that may be connected to a line, as determined by the total RENs, contact the local telephone company. For products approved after July 23, 2001, the REN for this product is part of the product identifier that has the following format:

- US:AAAEQ##TXXXX

The digits represented by ## are the REN without a decimal point (e.g., 04 is a REN of 0.4). For earlier products, the REN is separately shown on the label.

3. Incidence of Harm to the Telephone Lines

If this equipment causes harm to the telephone network, the telephone company will notify you in advance that temporary discontinuance of service may be required. But if advance notice isn't practical, the telephone company will notify the customer as soon as possible. Also, you will be advised of your right to file a complaint with the FCC if you believe it is necessary.

4. Changes in Telephone Company Communications Facilities, Equipment, Operations and Procedures

The telephone company may make changes in its facilities, equipment, operations or procedures that could affect the operation of the equipment. If this happens the telephone company will provide advance notice in order for you to make necessary modifications to maintain uninterrupted service.

5. Trouble with this equipment

If trouble is experienced with this equipment, for repair or warranty information, please see the attached warranty, which includes the Service Center Directory. If the equipment is causing harm to the telephone network, the telephone company may request that you disconnect the equipment until the problem is resolved.

6. Connection to Party Line

Connection to party line service is subject to state tariffs. Contact the state public utility commission, public service commission or corporation commission for information.

7. Combined Use with Alarm Equipment

If your home has specially wired alarm equipment connected to the telephone line, ensure the installation of this equipment does not disable your alarm equipment. If you have questions about what will disable alarm equipment, consult your telephone company or a qualified installer.

Note

This equipment has been tested and found to comply with the limits for a Class B digital device, pursuant to Part 15 of the FCC Rules. These limits are designed to provide reasonable protection against harmful interference in a residential installation. This equipment generates, uses, and can radiate radio frequency energy and, if not installed and used in accordance with the instructions, may cause harmful interference to radio communications. However, there is no guarantee that interference will not occur in a particular installation. If this equipment does cause harmful interference to radio or television reception, which can be determined by turning the equipment off and on, the user is encouraged to try to correct the interference by one or more of the following measures:

- Reorient or relocate the receiving antenna.
- Increase the separation between the equipment and receiver.
- Connect the equipment into an outlet on a circuit different from that to which the receiver is connected.
- Consult the dealer or an experienced radio/TV technician for help.

CAUTION

Any changes or modifications not expressly approved by the party responsible for compliance could void the user's authority to operate this device.

When programming emergency numbers and/or making test calls to emergency numbers:

1. Remain on the line and briefly explain to the dispatcher the reason for the call before hanging up.
2. Perform such activities in the off-peak hours, such as early morning hours or late evenings.

WARNING

The software contained in the TRS feature to allow user access to the network must be upgraded to recognize newly established network area codes and exchange codes as they are placed into service. Failure to upgrade the premises PBXs or peripheral equipment to recognize the new codes as they are established will restrict the customer and the customer's employees from gaining access to the network and to these codes.

KEEP THE SOFTWARE UP-TO-DATE WITH THE LATEST DATA.

Table of Contents

1	Operation	13
1.1	Before Operating a Telephone	14
1.1.1	Before Operating a Telephone	14
1.2	Basic Operations	22
1.2.1	Making Calls	22
1.2.2	Receiving Calls	24
1.3	Telephone Features	25
1.3.1	Absent Message	25
1.3.2	Account Code Entry	26
1.3.3	Alternate Calling—Ring/Voice	28
1.3.4	Answering, Direct Outside (CO) Line	28
1.3.5	Automatic Callback Busy (Camp-on)	29
1.3.6	Background Music (BGM)	30
1.3.7	Built-in Voice Message (BV)	31
1.3.8	Busy Station Signaling (BSS)	41
1.3.9	Call Forwarding (FWD)—SUMMARY	42
1.3.10	Call Forwarding (FWD)—All Calls	43
1.3.11	Call Forwarding (FWD)—Busy/No Answer	44
1.3.12	Call Forwarding (FWD)—Follow Me	45
1.3.13	Call Forwarding (FWD)—To Outside (CO) Line	45
1.3.14	Call Forwarding (FWD)—CANCEL	46
1.3.15	Call Hold	47
1.3.16	Call Hold, Exclusive	48
1.3.17	Call Hold Retrieve	49
1.3.18	Call Log, Incoming	51
1.3.19	Call Log Display Lock, Incoming in the Personal Area	56
1.3.20	Call Park	57
1.3.21	Call Pickup, Directed	59
1.3.22	Call Pickup, Group	59
1.3.23	Call Pickup Deny	60
1.3.24	Call Retrieving from a TAM (Telephone Answering Machine)	61
1.3.25	Call Splitting	61
1.3.26	Call Transfer—To Extension	63
1.3.27	Call Transfer—To Outside (CO) Line	64
1.3.28	Call Waiting	66
1.3.29	Call Waiting Caller ID	68
1.3.30	Call Waiting from the Telephone Company	70
1.3.31	Conference	71
1.3.32	Conference, Unattended	73
1.3.33	Data Line Security	74
1.3.34	Direct Inward System Access (DISA)	75
1.3.35	Do Not Disturb (DND)	79
1.3.36	Do Not Disturb (DND) Override	80
1.3.37	Door Open	81
1.3.38	Doorphone Call	82
1.3.39	Emergency Call	83
1.3.40	Executive Busy Override—Extension	84

1.3.41	Executive Busy Override—Outside (CO) Line	86
1.3.42	Executive Busy Override Deny	87
1.3.43	Extension Feature Clear	88
1.3.44	Extension Lock.....	88
1.3.45	External Feature Access (EFA).....	90
1.3.46	Flash/Recall	91
1.3.47	Hands-free Answerback.....	92
1.3.48	Hands-free Operation	92
1.3.49	Headset Operation.....	93
1.3.50	Hot Line	94
1.3.51	Intercom Call.....	95
1.3.52	Line Access, Outside (CO) Line—SUMMARY	96
1.3.53	Line Access, Automatic.....	97
1.3.54	Line Access, Outside (CO) Line Group.....	98
1.3.55	Line Access, S-CO Line.....	99
1.3.56	Live Call Screening (LCS) (Voice Mail APT Integration only)	100
1.3.57	Local Carrier-based Voice Mail Service	103
1.3.58	Lockout	104
1.3.59	Log-in/Log-out.....	105
1.3.60	Message Waiting	106
1.3.61	Message Waiting for Another Extension	109
1.3.62	Message Waiting for Another Extension Lock	110
1.3.63	Microphone Mute	111
1.3.64	One-touch Dialing	111
1.3.65	Operator Call.....	112
1.3.66	Paging—SUMMARY	113
1.3.67	Paging—All Extensions.....	114
1.3.68	Paging—All Extensions & External	114
1.3.69	Paging—External.....	115
1.3.70	Paging—Group	115
1.3.71	Paging and Transfer.....	116
1.3.72	Paging Answer	117
1.3.73	Paging Deny	117
1.3.74	Paralleled Telephone.....	118
1.3.75	Personal Speed Dialing	118
1.3.76	Power Failure Transfer	120
1.3.77	Pulse to Tone Conversion	120
1.3.78	Redial, Last Number	121
1.3.79	Redial, Saved Number.....	121
1.3.80	Room Monitor	122
1.3.81	Secret Dialing	124
1.3.82	System Speed Dialing	125
1.3.83	Time Service.....	126
1.3.84	Timed Reminder	127
1.3.85	Toll Restriction (TRS).....	129
1.3.86	Toll Restriction (TRS) Override by Account Code.....	129
1.3.87	Two-way Recording in the VPS (Voice Mail APT Integration only).....	129
1.3.88	Voice Mail Integration.....	130
1.3.89	Voice Mail Transfer (Voice Mail APT Integration only).....	133
1.3.90	Walking COS	134

2	Operator/Manager Operation.....	135
2.1	Operator/Manager Service Features	136
2.1.1	Call Log, Incoming in the Common Area—CLEAR ALL	136
2.1.2	Call Log Display Lock, Incoming in the Common Area	136
2.1.3	Common BV Outgoing Messages.....	137
2.1.4	Manager Programming (Manager only)	139
2.1.5	Outgoing Message (OGM) for DISA	140
2.1.6	Remote Extension Lock	143
2.1.7	System Feature Assignment.....	145
2.1.8	The 301st Call Log, Incoming in the Common Area Treatment	146
2.1.9	Time Service	147
2.1.10	Timed Reminder, Remote (Wake-up Call)	149
3	Customizing Your Phone & PBX	153
3.1	Personal Programming.....	154
3.1.1	Programming Information.....	154
3.1.2	Personal Feature Assignment	154
3.1.3	Flexible Button Assignment.....	157
3.2	System Programming (Manager Programming)	161
3.2.1	Programming Information.....	161
3.2.2	System Programming (Manager Programming)	163
4	Appendix	167
4.1	Troubleshooting	168
4.1.1	Troubleshooting.....	168
4.2	Feature Number Table	171
4.2.1	Feature Number Table.....	171
4.3	Tone List	177
4.3.1	Tone List.....	177
4.4	Revision History.....	182
4.4.1	Version 2.0	182
Index	187

Section 1

Operation

*This chapter shows you step by step how to use each feature.
Read this chapter to become familiar with the many useful
features of this PBX.*

1.1 Before Operating a Telephone

1.1.1 Before Operating a Telephone

◆◆ What Kind of Telephone Can Be Used?

You can use a single line device such as a single line telephone (SLT), fax machine, modem, or wireless telephone, or a Panasonic proprietary telephone (PT) such as the KX-T7731. Some features may not be available, depending on the telephone you are using.

If you are using a Panasonic PT with special feature buttons, or a display (Display PT), or both, follow the procedures that use feature buttons or the display, for easy operation.

If you are using an SLT, follow the procedures that use specified numbers to access features (feature numbers).

If you use a Direct Station Selection (DSS) Console, you can also use the buttons on the DSS Console to perform operations, instead of the buttons on the connected PT.

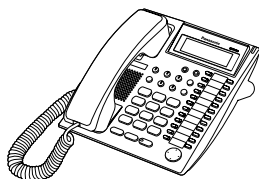

- If you use a Panasonic PT that does not have feature buttons, you may change one of the unused flexible buttons to a feature button. Refer to "3.1.3 Flexible Button Assignment".

◆◆ Feature Numbers

Features have been assigned feature numbers, which can be entered on your telephone to access the corresponding feature. Some features are only accessible by entering the feature number. In addition, some features require other additional parameters to be entered to activate the feature. Where necessary, these are specified in the text.



If you use an SLT that does not have the "*" or "#" keys,
it is not possible to access features that have "*" or "#" in their feature numbers.

◆◆ Tone

Various tones are used during or after operations to provide you with information. For more details regarding the types of tones and their meanings, refer to "4.3.1 Tone List" (Appendix).

◆◆ Display

In this manual, you will see the phrase "the display ...". This refers to the display of a Panasonic PT. When you use a Panasonic display PT, displayed messages or items help you to operate the telephone.

Your Extension Number

If you use a Panasonic display PT, you can confirm your own extension number by pressing the "*" key 2 times ("**") while on-hook, or by accessing personal programming. For more details, refer to "3.1.2 Personal Feature Assignment—Self-extension Number Confirmation".

◆◆ Using a Navigator Key/Volume Key (depending on the type of your PT)

The Navigator Key can be used to control display contrast and volume, or to search for items using the display. Pressing the Navigator Key in the desired direction will change the contrast, volume level or items displayed, as shown below. On PTs with a Volume Key, this key can be used to adjust the volume, as shown below.

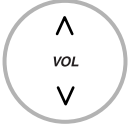
Navigator Key	Volume Key
<p>Up (Level increases)</p>  <p>Left ◀ ▶ Right</p> <p>Down (Level decreases)</p>	<p>Up (Level increases)</p>  <p>Down (Level decreases)</p>

◆◆ Examples









The displays and the illustrations shown throughout this manual as examples are of a telephone connected to the KX-TA824.

◆◆ Restrictions



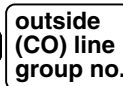

Features that have been restricted through system programming will not be available at your extension.

◆◆ Icon Descriptions

The following icons are used frequently throughout this manual.

 No SLT	This feature cannot be used with an SLT.	   	Seize an outside (CO) line by doing one of the following: <ul style="list-style-type: none"> • Press a CO button. • Dial the automatic line access number (9). • Dial the outside (CO) line group access number (8) and outside (CO) line group number.
	See "Programming" for related programming, if necessary.		
	Go off-hook by doing any of the following: <ul style="list-style-type: none"> • Lift the handset. • Press the SP-PHONE button. • Press the MONITOR button. (To start talking, lift the handset.) 		Press the Call button on the Doorphone.





1.1 Before Operating a Telephone















	<p>Go on-hook by doing any of the following:</p> <ul style="list-style-type: none"> • Hang up. • Press the SP-PHONE button. • Press the MONITOR button. 		<p>Press the Recall/hookswitch briefly.</p>
	<p>Talk.</p>	<p>desired no.</p>	<p>Enter the required number. <Example></p> <p>account code</p> <p>Enter the account code.</p>
	<p>You will hear a busy, confirmation, dial, or ringback tone.</p> <p>B. Tone: Busy Tone C. Tone: Confirmation Tone D. Tone: Dial Tone R. B. Tone: Ringback Tone</p>	<p>extension no.</p>	<p>Dial an extension number.</p>
<p>outside phone no.</p>	<p>Dial an outside telephone number.</p>	<p>phone no.</p>	<p>Dial an extension number or outside telephone number.</p>

◆◆ When You Use a Panasonic Proprietary Telephone

If you use a Panasonic PT or DSS Console, you will be able to use some of the useful feature buttons described below. These buttons simplify certain operations. The illustrations below may differ from the actual buttons on your telephone.

Fixed Buttons

 	<p>CO: Used to access an outside (CO) line (or outside (CO) line group) when making or receiving a call. The button's preprogrammed Outside (CO) Line Access method determines which line is selected. Can also be customized as a feature button.</p>		<p>SP-PHONE: Used to select handset or hands-free operation.</p>
	<p>AUTO DIAL/STORE: Used for System Speed Dialing/Saved Number Redial, playing back personal/common BV outgoing messages (OGMs) used by the Built-in Voice Message (BV) feature, and storing program changes.</p>		<p>PAUSE: Used to insert a dialing pause in a stored number.</p>

	<p>REDIAL: Used to redial the last number dialed.</p>		<p>MESSAGE: Used to leave a message waiting indication, call back the party who left a message waiting indication, or play back voice messages. This button is provided with an LED (Light Emitting Diode), except for on KX-T7700/KX-TA30800 series telephones. With KX-T7700/KX-TA30800 series telephones, the Message/Ringer Lamp is lit when a message waiting indication is left at your extension.</p>
	<p>INTERCOM: Used to make or receive intercom calls.</p>		<p>MONITOR: Used to select hands-free dialing and monitor operation.</p>
	<p>AUTO ANS (Auto Answer)/MUTE: Used to answer an intercom call automatically in hands-free mode or to mute the built-in microphone during a conversation.</p>		<p>TRANSFER: Used to transfer a call to another party.</p>
	<p>HOLD: Used to place a call on hold.</p>		<p>FLASH/RECALL: Used to disconnect the current call and make another call without hanging up, or to send an EFA (External Feature Access) signal to the telephone company or host PBX to access external features.</p>
	<p>CONF (Conference): Used to establish a 3-party conference call.</p>		<p>VOICE CALL: Used to answer an intercom call automatically.</p>
	<p>FWD/DND (Call Forwarding/Do Not Disturb): Used to set the FWD or DND feature for the extension.</p>		<p>PROGRAM: Used to enter and exit programming mode.</p>
	<p>Navigator Key: Used to adjust the volume of the speaker, handset and headset, and the display contrast, or to select desired items.</p>		<p>Programmable Feature (PF): <i>Located in the right column of the CO button array on certain telephones or on the DSS Console.</i> Used to access a preprogrammed feature. Mostly used as a One-touch Dialing button.</p>
	<p>Volume Key: Used to adjust the volume of the speaker, handset and headset.</p>		

Customized Buttons

Throughout this manual, when the name of a button is written in parentheses, such as "(G-CO)", this means that it is a flexible button that has been customized. To customize flexible buttons, refer to "3.1.3 Flexible Button Assignment".

1.1 Before Operating a Telephone

Customized Button	Function
Single-CO (S-CO)	Used to access a specified outside (CO) line for making or receiving calls.
Group-CO (G-CO)	Used to access an idle outside (CO) line in a specified outside (CO) line group for making calls. Incoming calls from outside (CO) lines in the assigned outside (CO) line group arrive at this button.
Other-CO (O-CO)	Used to access an idle outside (CO) line for making calls. Incoming calls from the assigned outside (CO) lines, which are not assigned to S-CO or G-CO buttons, arrive at this button.
Direct Station Selection (DSS)	Used to call an extension with a one-touch operation.
One-touch Dialing	Used to call a preprogrammed party or access a feature with a one-touch operation.
Message	Used to leave a message waiting indication, call back the party who left the message waiting indication, or play back voice messages.
Message for Another Extension	Used to access messages (except Built-in Voice Message [BV] messages) left for another extension or voice messages stored in another extension's Voice Processing System (VPS) mailbox.
FWD/DND (Call Forwarding/Do Not Disturb)	Used to set the FWD or DND feature for the extension.
Save	Used to store a telephone number while in a conversation with an outside party or while hearing a busy tone, and then easily redial the number later.
Conference	Used to establish a 3-party conference call.
Log-in/Log-out	Used to switch between Log-in and Log-out status.
Extension Lock	Used to remotely lock or unlock another extension.
Day	Used to change the time service mode to day mode.
Night	Used to change the time service mode to night mode.
Lunch	Used to change the time service mode to lunch mode.
Caller ID Indication—Common	Used to inform you of calls logged in the common area, store the information of an incoming call during a conversation, and view caller information while on-hook and then call back a caller.
Caller ID Indication—Personal	Used to inform you of calls logged in your personal area, store the information of an incoming call during a conversation, and view caller information while on-hook and then call back a caller.
Caller ID Selection—Common	Used to display and cycle through the information of an incoming call during a conversation, while receiving a call, or while viewing caller information, display the number of logged calls while on-hook, and inform you that the common area call log is full.
Caller ID Selection—Personal	Used to display and cycle through the information of an incoming call during a conversation, while receiving a call, or while viewing caller information, display the number of logged calls while on-hook, and inform you that the personal area call log is full.
2-way Record	Used to record a conversation into your own mailbox.

Customized Button	Function
2-way Transfer	Used to record a conversation into the mailbox of a specified extension.
Live Call Screening (LCS)	Used to listen while a caller is leaving a message in your voice mailbox and, if desired, intercept the call.
LCS Cancel	Used to stop monitoring your own voice mailbox while a caller is leaving a message, or stop the alert tone heard in Private mode while a caller is leaving a message.
Voice Mail (VM) Transfer	Used to transfer a call to the mailbox of a specified extension.

**Feature Manual References**

- 1.1.59 Fixed Buttons
- 1.1.61 Flexible Buttons

◆◆ How to Follow the Steps

An example system operation procedure is shown below.

◆◆ Intercom Call

You can call another extension.

Feature title

PT/SLT

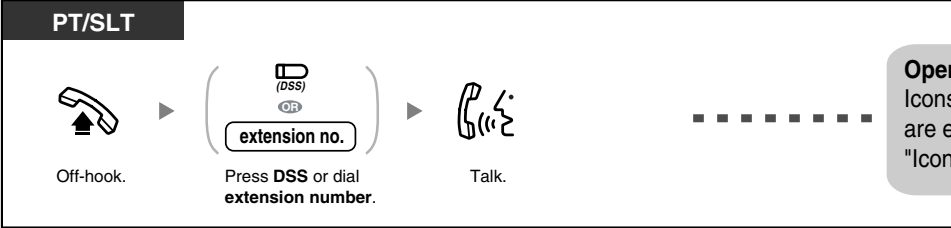

Operation steps
Icons and meanings are explained in "Icon Descriptions".

Conditions

- If you use a Panasonic display proprietary telephone (PT), you can confirm your own extension number by pressing the "✖" key 2 times ("✖✖") while on-hook, or by accessing personal programming. For more details, refer to "3.1.2 Personal Feature Assignment—Self-extension Number Confirmation".
- **Hands-free Operation**
You can make an intercom call and have a conversation in hands-free mode using the SP-PHONE/INTERCOM button. Refer to "1.3.48 Hands-free Operation".

Hints

Operating Manual References

- 1.3.48 Hands-free Operation
- 1.3.51 Intercom Call
- 3.1.2 Personal Feature Assignment—Self-extension Number Confirmation

References: Related or required programming is noted.

- **!!** If your telephone type is not included in the operation steps, for example, only "PT" is marked and you are using an SLT, your telephone cannot execute that feature.
- If your telephone can use several methods to execute one feature, you can select the preferred method according to your needs.

◆◆ Connection Example

This diagram shows devices that can be connected.

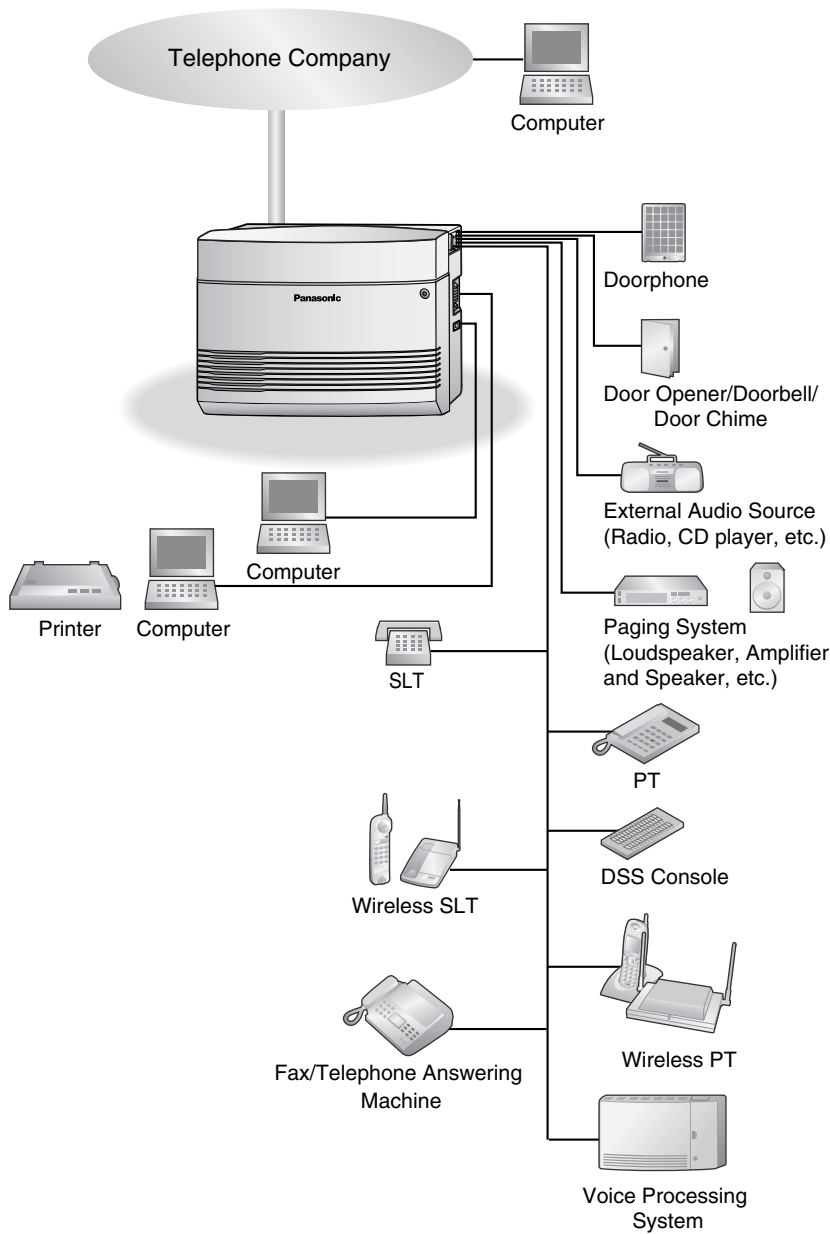

1.2 Basic Operations

1.2.1 Making Calls

- Intercom Call
- Line Access, Outside (CO) Line

◆◆ Intercom Call

You can call another extension.

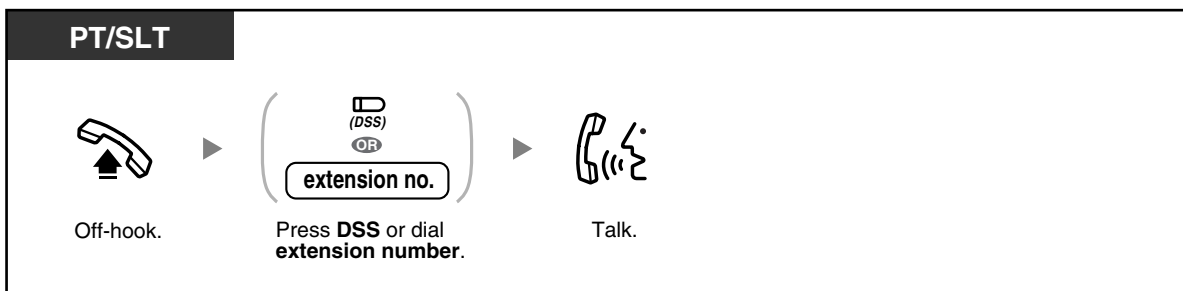

- If you use a Panasonic display proprietary telephone (PT), you can confirm your own extension number by pressing the "*" key 2 times ("**") while on-hook, or by accessing personal programming. For more details, refer to "3.1.2 Personal Feature Assignment—Self-extension Number Confirmation".



- **Hands-free Operation**
You can make an intercom call and have a conversation in hands-free mode using the SP-PHONE/INTERCOM button. Refer to "1.3.48 Hands-free Operation".



Operating Manual References

- 1.3.48 Hands-free Operation
- 1.3.51 Intercom Call
- 3.1.2 Personal Feature Assignment—Self-extension Number Confirmation

◆◆ Line Access, Outside (CO) Line

You can call an outside party using one of the following Outside (CO) Line Access methods:

Line Access, Automatic

Line Access, Outside (CO) Line Group

Line Access, S-CO Line

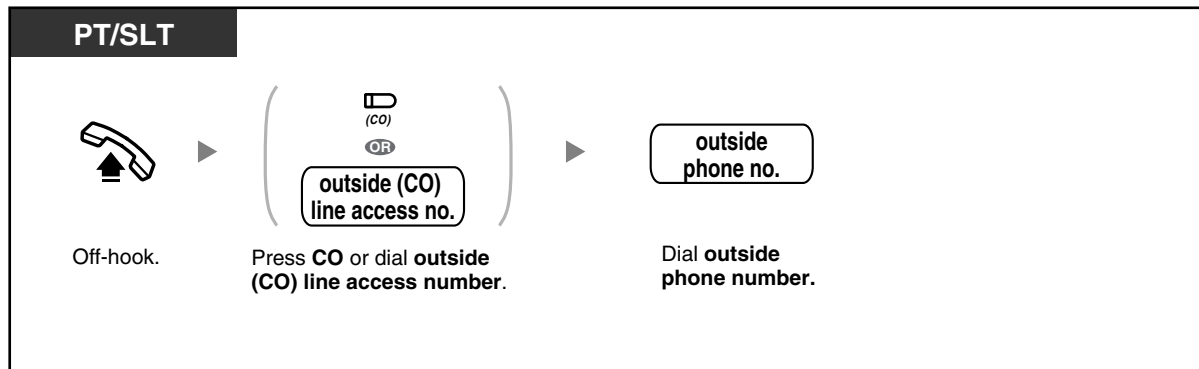

- Through personal programming, a proprietary telephone (PT) user can select the preferred method (Idle Line/No Line/Prime Line) of seizing a line to be used each time the user goes off-hook.



- **Hands-free Operation**
You can make an outside (CO) line call and have a conversation in hands-free mode using the SP-PHONE button. Refer to "1.3.48 Hands-free Operation".



Programming Manual References

[PT Programming]

- [405-407] Flexible Outward Dialing—Day/Night/Lunch

[PC Programming]

- 9.3.2 Incoming / Outgoing [3-2]—Outgoing Call—Day, Night, Lunch

Operating Manual References

- 1.3.48 Hands-free Operation
- 1.3.52 Line Access, Outside (CO) Line—SUMMARY
- 3.1.2 Personal Feature Assignment—**Line Preference—Outgoing**
Select the seized line when going off-hook.

1.2.2 Receiving Calls

PT/SLT

When your telephone rings, either the CO/INTERCOM button or the Message/Ringer Lamp flashes.



Off-hook.

▶



Talk.

Select one of the following methods:

- Lift the handset to receive the call on the preferred line. (Default: Ringing line is selected.)
- Press the SP-PHONE button.
- Press the flashing CO or INTERCOM button directly.



- Through personal programming, a proprietary telephone (PT) user can select the method used to answer incoming calls from the 3 line preferences (No Line/Prime Line/Ringing Line).



- **Hands-free Operation**
You can receive a call and have a conversation in hands-free mode using the SP-PHONE button. Refer to "1.3.48 Hands-free Operation".



Programming Manual References

[PT Programming]

- [400] CO Line Connection
- [408-410] Flexible Ringing—Day/Night/Lunch

[PC Programming]

- 9.3.2 Incoming / Outgoing [3-2]—Ringling for incoming CO calls—Day, Night, Lunch
- 9.3.3 Detail [3-3]—Connection

Operating Manual References

- 1.3.4 Answering, Direct Outside (CO) Line
- 1.3.48 Hands-free Operation
- 3.1.2 Personal Feature Assignment—
Line Preference—Incoming
Select the method used to answer incoming calls.
Alternate Receiving—Ring/Voice
Select the Calling method, either ring or the other party's voice.

1.3 Telephone Features

1.3.1 Absent Message

If you are unable to answer calls, you can select a brief message that will be shown on the displays of Panasonic display proprietary telephone (PT) users when they call you. The message you select can explain the reason for your absence, and is also shown on the display of your PT every time you go off-hook.

Message no.	Message
1	Will Return Soon
2	Gone Home
3	At Ext %%% (Extension number)
4	Back at %:%% (Hour:Minute) AM (or PM)
5	Out Until %/%% (Month/Day)
6	In a Meeting

To set

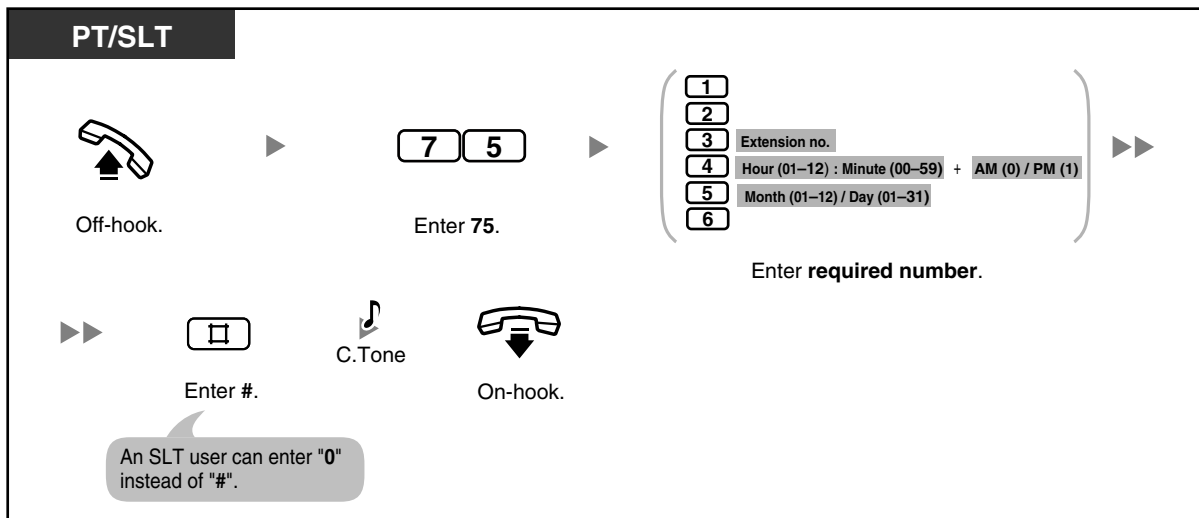

To cancel

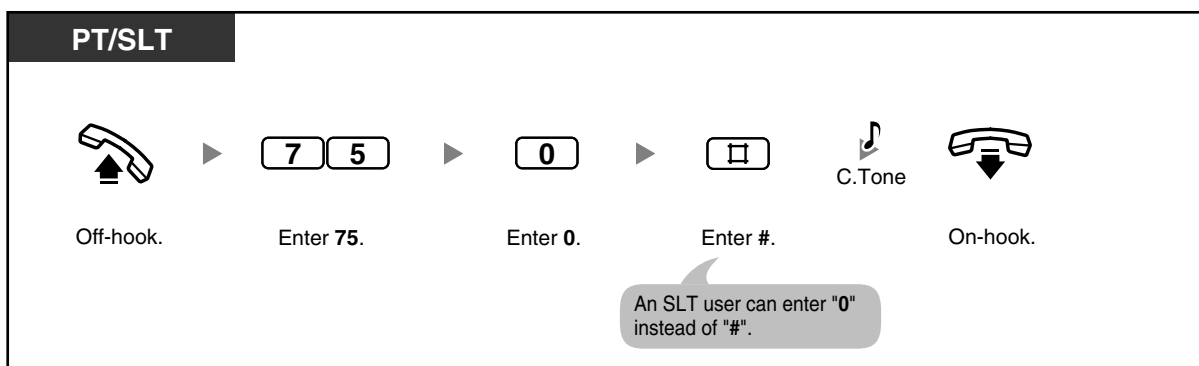

To confirm

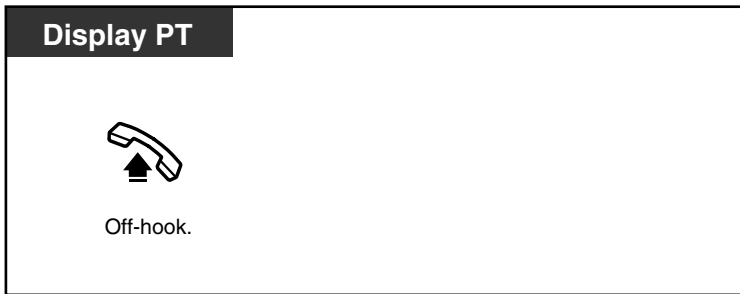

- Enter the desired value in the "%" positions. You must enter the number of digits represented by the number of "%" symbols.



Feature Manual References

- 1.1.1 Absent Message

1.3.2 Account Code Entry

The manager may give personal account codes to extension users, and check their telephone usage for accounting purposes. Alternatively, an account code can be specified for each customer, to log call durations for billing purposes.

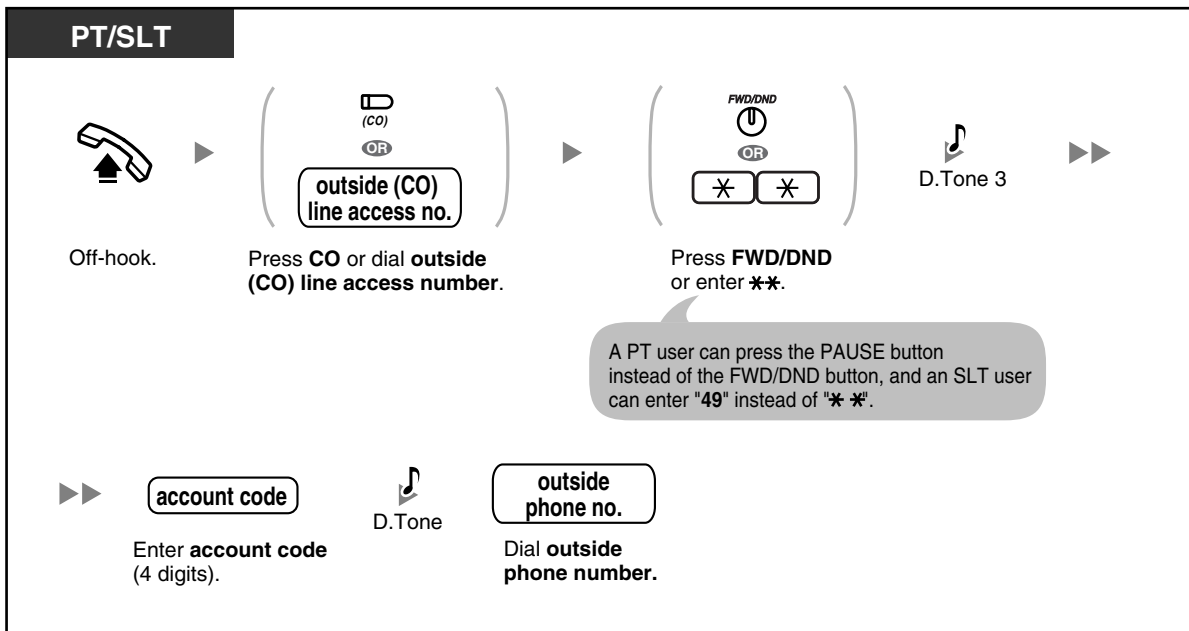



- You may not be able to make an outside (CO) line call without entering an account code depending on your telephone's mode of account code entry. The mode is assigned to each extension. For more details, refer to "1.1.2 Account Code Entry" in the Feature Manual.
- **A Panasonic proprietary telephone (PT) user** can enter an account code during a conversation or within 30 seconds after the other party hangs up (while hearing a reorder tone), by pressing the FWD/DND (Call Forwarding/Do Not Disturb) button, then entering the account code.
- Account codes may use the digits "0 through 9". Non-numeric codes such as FLASH/RECALL and PAUSE cannot be used.
- You can clear the account code by pressing the "××" key or FWD/DND button while entering the account code, and then re-enter the account code.



- **If you hear a reorder tone after entering the account code**, the account code entered does not exist. Enter the correct code.
- **For your convenience**, you can store a code together with a phone number in the telephone's memory (e.g., Speed Dialing).



Programming Manual References

[PT Programming]

- [310] Account Code
- [601-603] TRS-COS—Day/Night/Lunch
- [605] Account Code Mode
- [805] SMDR Account Code

[PC Programming]

- 9.1.6 Account Codes [1-5]
- 9.1.8 SMDR [1-7]—Selection for Printing—Account Code
- 9.2.1 Main [2-1]—Account Code Mode
- 9.5.1 Class of Service (COS) [5-1]—Day, Night, Lunch

Feature Manual References

- 1.1.2 Account Code Entry
- 1.1.112 Station Message Detail Recording (SMDR)
- 1.1.118 Toll Restriction (TRS) Override by Account Code

Operating Manual References

- 3.1.3 Flexible Button Assignment
Create or edit an FWD/DND (Call Forwarding/Do Not Disturb).

1.3.3 Alternate Calling—Ring/Voice

Proprietary telephone (PT) users can choose whether to be alerted to incoming calls by ringing or by the caller's voice (Alternate Receiving—Ring/Voice). The calling extension can override this choice and use the alternate method.

Ring (Default): You can call the other party with a ring tone. You will hear a ringback tone.

Voice-calling: You can talk to the other party immediately after hearing a confirmation tone. You will not hear a ringback tone. You will not be able to hear the other party's voice until he or she answers the call.

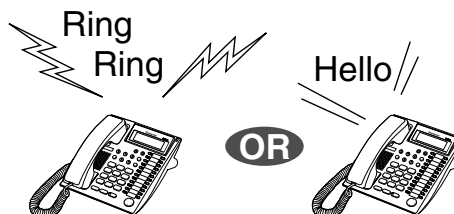

To switch the calling method

PT/SLT

After dialing an extension number



Enter *.



C.Tone or
R.B.Tone



Talk.



- If the called party uses a single line telephone (SLT), Voice-calling is not available.
- Rotary SLT users cannot use this feature.



Feature Manual References

- 1.1.69 Intercom Call

Operating Manual References

- 3.1.2 Personal Feature Assignment—**Alternate Receiving—Ring/Voice**
Select the alerting method, either ring or the other party's voice.

1.3.4 Answering, Direct Outside (CO) Line

You can answer an incoming outside (CO) line call by pressing a CO button on your proprietary telephone (PT). You do not have to lift the handset or press the SP-PHONE/MONITOR button.



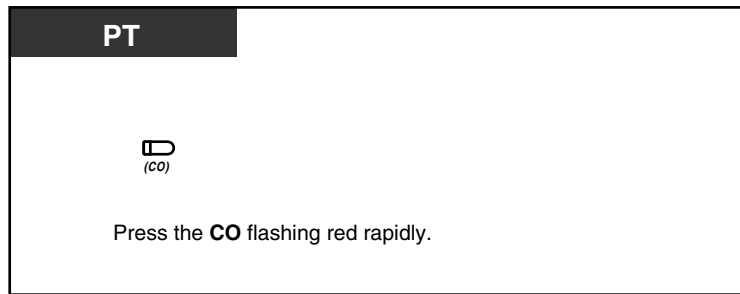

- You can choose which line to answer when multiple incoming outside (CO) line calls arrive at the same time by pressing the preferred CO button.



Feature Manual References

- 1.1.3 Answering, Direct Outside (CO) Line

Operating Manual References

- 1.3.48 Hands-free Operation
- 3.1.2 Personal Feature Assignment—**Line Preference—Incoming**
Select the method used to answer incoming calls.
- 3.1.3 Flexible Button Assignment
Create or edit a Single-CO (S-CO) button, Group-CO (G-CO) button, or Other-CO (O-CO) button.

1.3.5 Automatic Callback Busy (Camp-on)

If a dialed extension or a desired outside (CO) line is busy, you can set the Automatic Callback Busy feature. Then, when the extension or outside (CO) line becomes idle, your telephone will ring automatically.

When you answer the callback ring:

- a dialed extension becomes idle.
- a desired outside (CO) line that is in use by another extension becomes idle.

You cannot set Automatic Callback Busy for a busy party outside of the PBX.

When you answer the callback ring:

- for an outside (CO) line call: the line is seized.
- for an intercom call: the called extension starts ringing automatically.

To set for both an outside (CO) line call and an intercom call

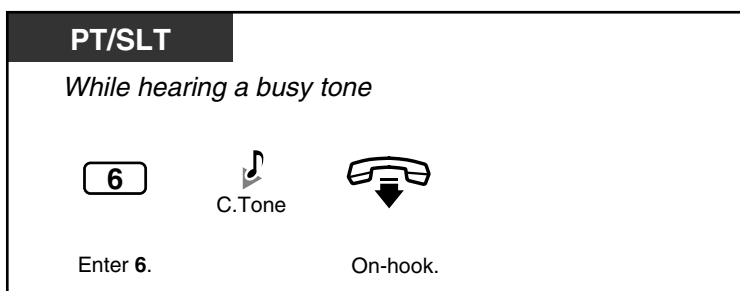

To answer a callback ring set for a busy extension

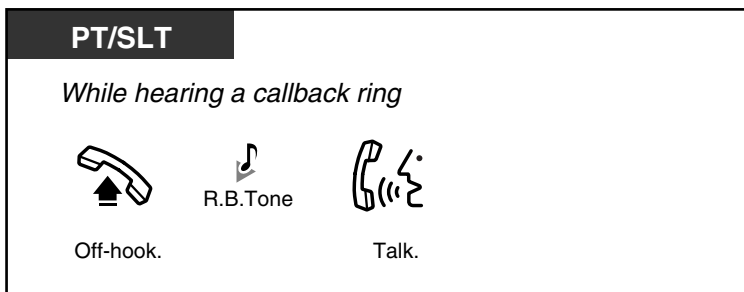

To answer a callback ring set for a busy outside (CO) line

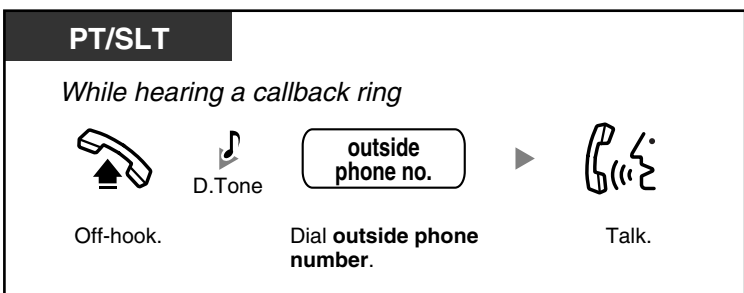

To cancel the callback ring (Automatic Callback Busy Cancel)



- If you do not answer the callback ring within 10 seconds (4 rings), this feature will be canceled.



Feature Manual References

- 1.1.4 Automatic Callback Busy (Camp-on)

1.3.6 Background Music (BGM)

You can listen to background music (BGM) through your telephone speaker while on-hook. If your extension becomes busy (off-hook, making or receiving a call etc.), the music will stop. When you go back on-hook, the music starts again.



To set/cancel

PT
<i>While on-hook</i>
1
Enter 1.



- Your PBX can be programmed not to play music when "1" is entered while on-hook.

**Programming Manual References****[PT Programming]**

- [111] Music on Hold
- [626] BGM Control for APT

[PC Programming]

- 9.1.2 Main [1-2]—Music on Hold
- 9.2.1 Main [2-1]—BGM Control for APT

Feature Manual References

- 1.1.7 Background Music (BGM)

1.3.7 Built-in Voice Message (BV)

- Recording, Playing, or Erasing Personal BV Outgoing Messages
- Forwarding Your Calls to Built-in Voice Message
- Leaving, Playing, or Erasing Voice Messages

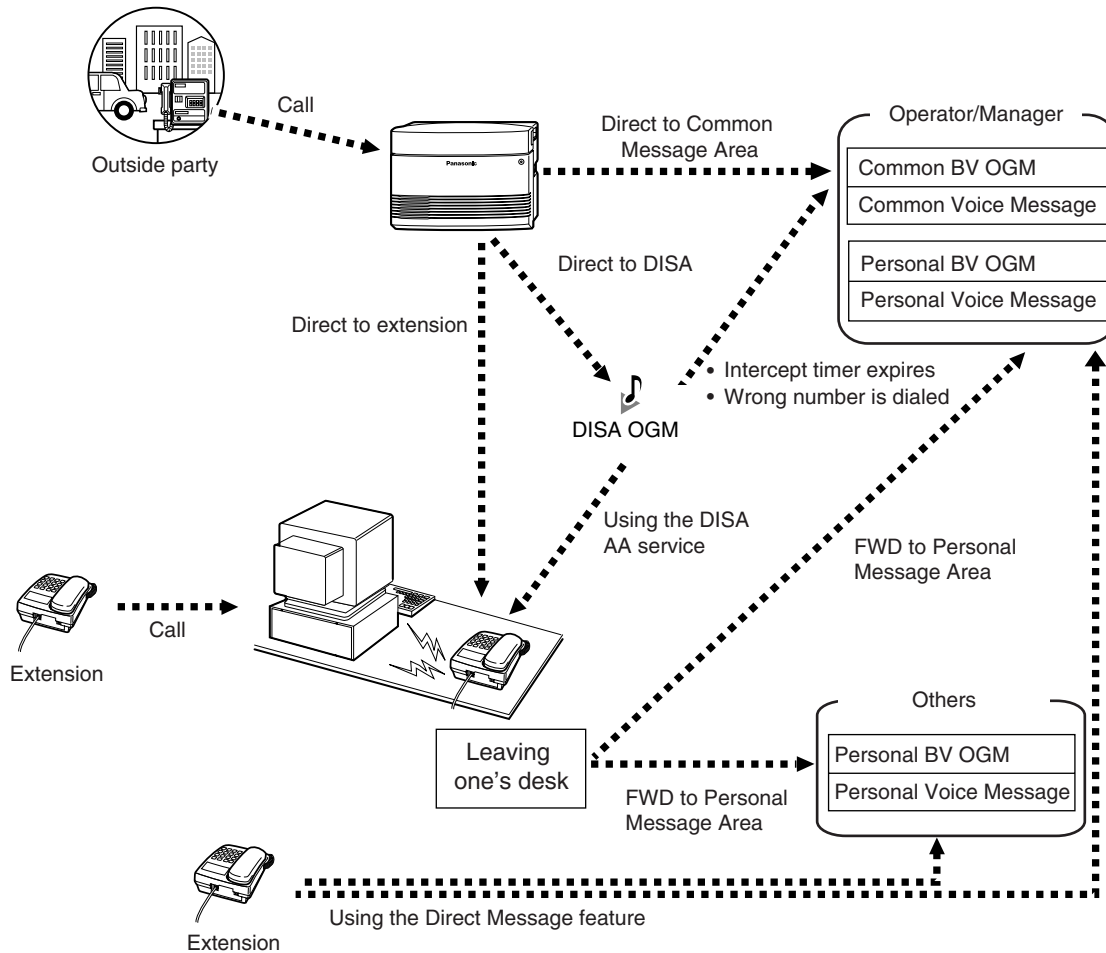

If an optional voice message card is installed in the PBX, a caller can leave a voice message in one of the voice message areas. There are 2 types of voice message area: personal message area and common message area.

A personal message area is where callers can leave messages directly for you. When an incoming call (a call direct to your extension, or a call using the Direct Inward System Access [DISA] Automated Attendant [AA] service) is forwarded to your personal message area, the caller will hear a personal Built-in Voice Message (BV) outgoing message (OGM) and can leave a voice message. You can access your personal message area to play back or erase caller messages.

A common message area is where callers can leave messages for the company. When an outside (CO) line call is automatically directed to the common message area, or when a DISA call is redirected to the common message area via Intercept Routing, the caller will hear a common BV OGM and can leave a voice message. Only the operator or manager can access the common message area to play back or erase caller messages.

If there are new voice messages in your personal message area or the common message area (if accessible), you will hear dial tone 4 when going off-hook. Additionally, if your telephone has a MESSAGE button or Message/Ringer Lamp, the corresponding button or lamp turns on when a message has been left. You can also perform the following operations:

- You can record, play, or erase a personal BV OGM for your personal message area.
- The operator or manager can record, play, or erase a common BV OGM for the common message area. Refer to "2.1.3 Common BV Outgoing Messages".
- You can set incoming calls to be forwarded to your personal message area, when you cannot answer them.

- You can leave a voice message in the personal message area of another extension, even if the extension has not been set to forward incoming calls to its personal message area, or even if no personal BV OGM has been recorded (Direct Message).
When a caller leaves a voice message using the Direct Message feature, the voice message is automatically linked to the caller information (including the extension number and name [if stored]) in the Incoming Call Log.
- You can access the personal/common message area from an outside telephone by using a preprogrammed voice message access code. The code to enter differs depending on whether you are calling directly to an extension (that is forwarded to the extension's message area) or to the common message area, or you are calling with DISA.

Call Log

When viewing caller information, you can see whether the caller left a voice message. For more details, refer to "1.3.18 Call Log, Incoming".

Notes

- If you set the Voice Mail Integration feature, the BV feature will not function.
- When another extension user is recording or erasing a personal/common BV OGM, you cannot perform any operations using the BV feature. When another extension user or an outside caller is performing operations other than those mentioned above, you may not be able to use the BV feature. In this case, wait a few minutes and try again.

◆◆ Recording, Playing, or Erasing Personal BV Outgoing Messages

To record

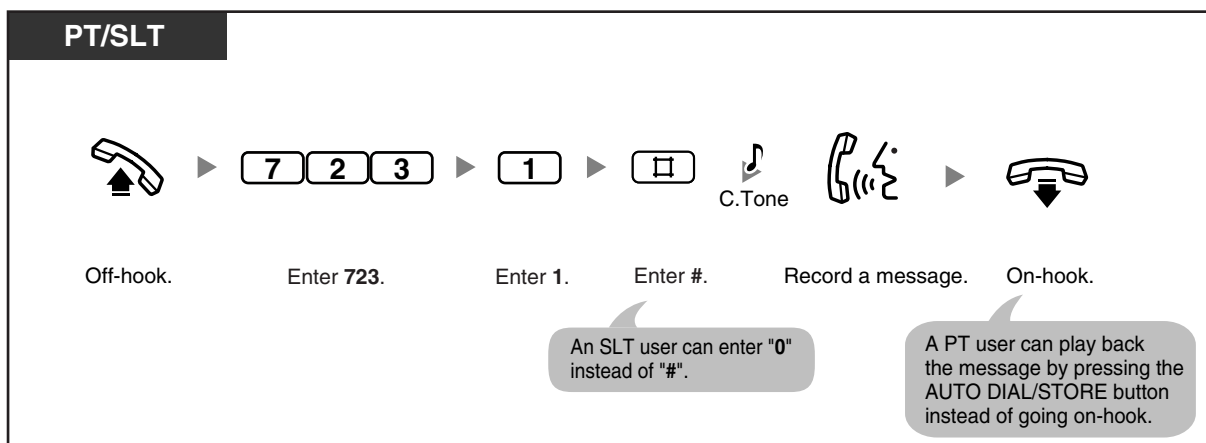

To play back

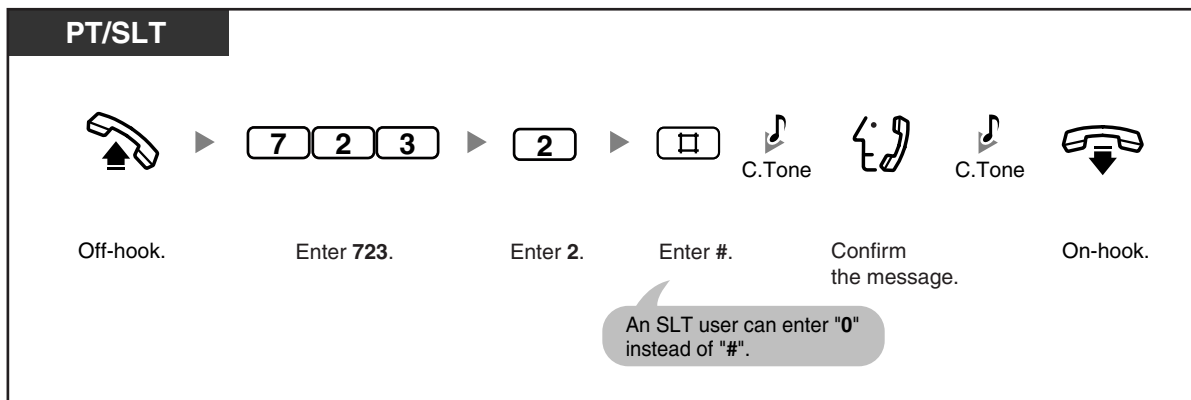

To erase

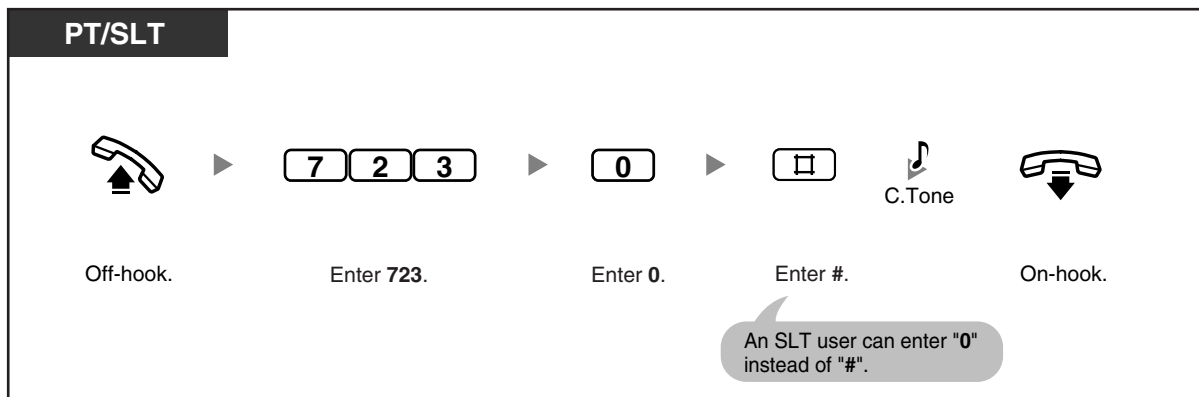

- The AUTO DIAL/STORE button light shows the current status as follows:
 - Off:** You are recording a message, or a message has finished playing.
 - Red on:** A message is playing.
- You can stop playback by pressing the AUTO DIAL/STORE button.



Operating Manual References

- 2.1.3 Common BV Outgoing Messages

◆◆ Forwarding Your Calls to Built-in Voice Message

To set/cancel

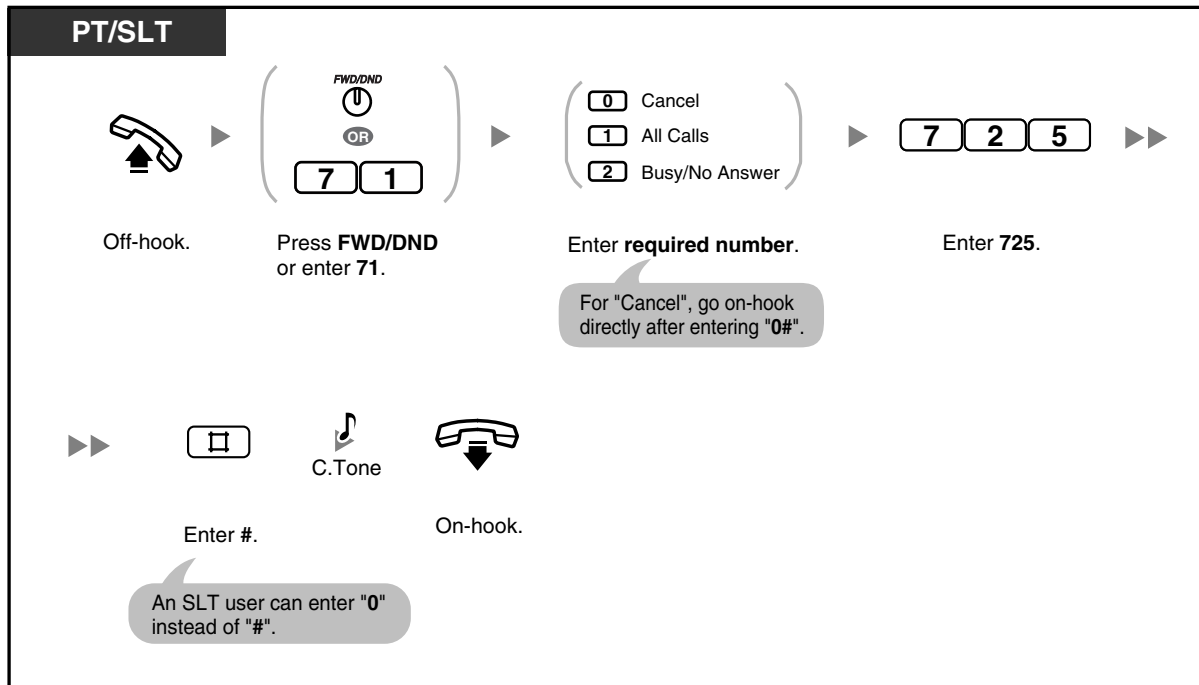

- Setting this feature also cancels other types of Call Forwarding (FWD)/Do Not Disturb (DND).



Programming Manual References

[PC Programming]

- 9.2.2 Feature settings [2-2]—FWD/DND

Operating Manual References

- 1.3.10 Call Forwarding (FWD)—All Calls
- 3.1.3 Flexible Button Assignment
Create or edit an FWD/DND (Call Forwarding/Do Not Disturb).

◆◆ Leaving, Playing, or Erasing Voice Messages

To leave a voice message in a user's personal message area

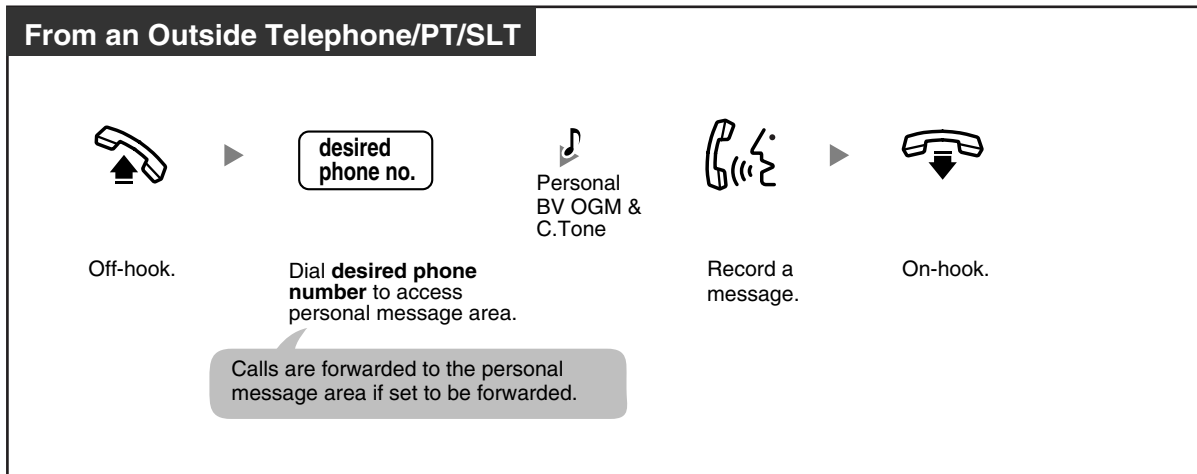

To leave a voice message in the common message area

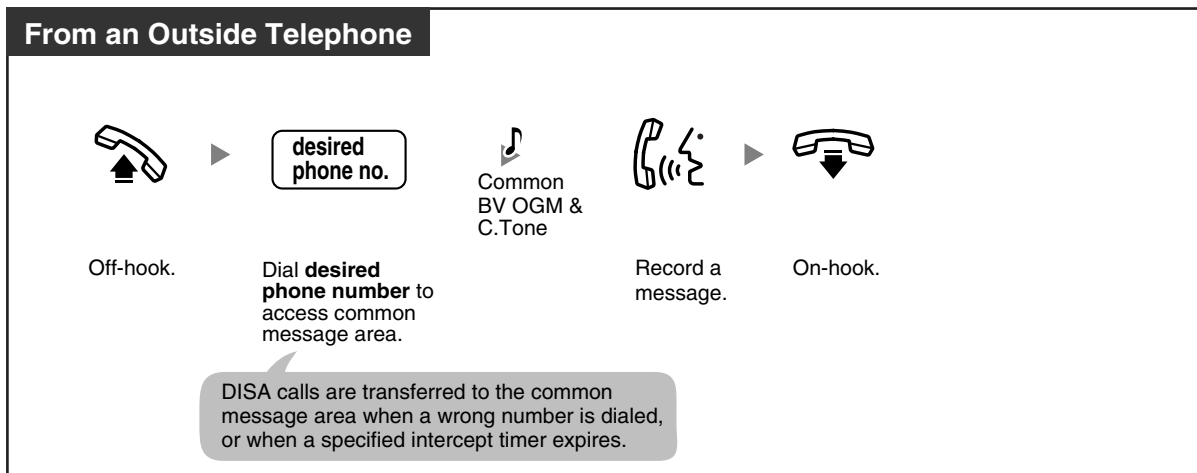

To leave a voice message using Direct Message

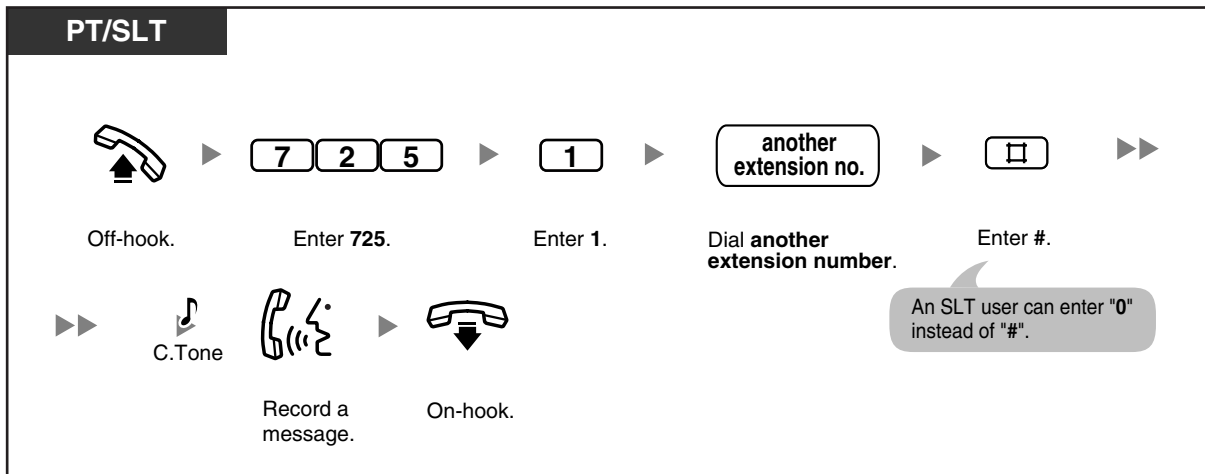

To view and play back a voice message in a voice message area

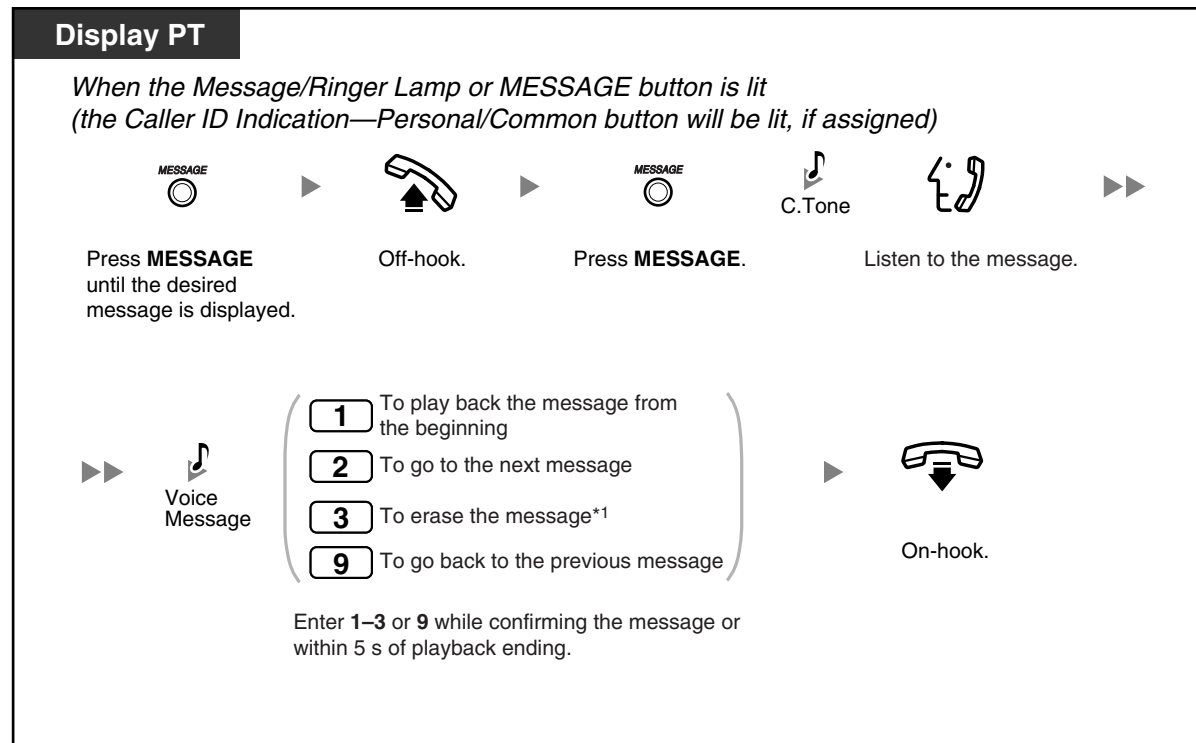

To play back all voice messages in a voice message area

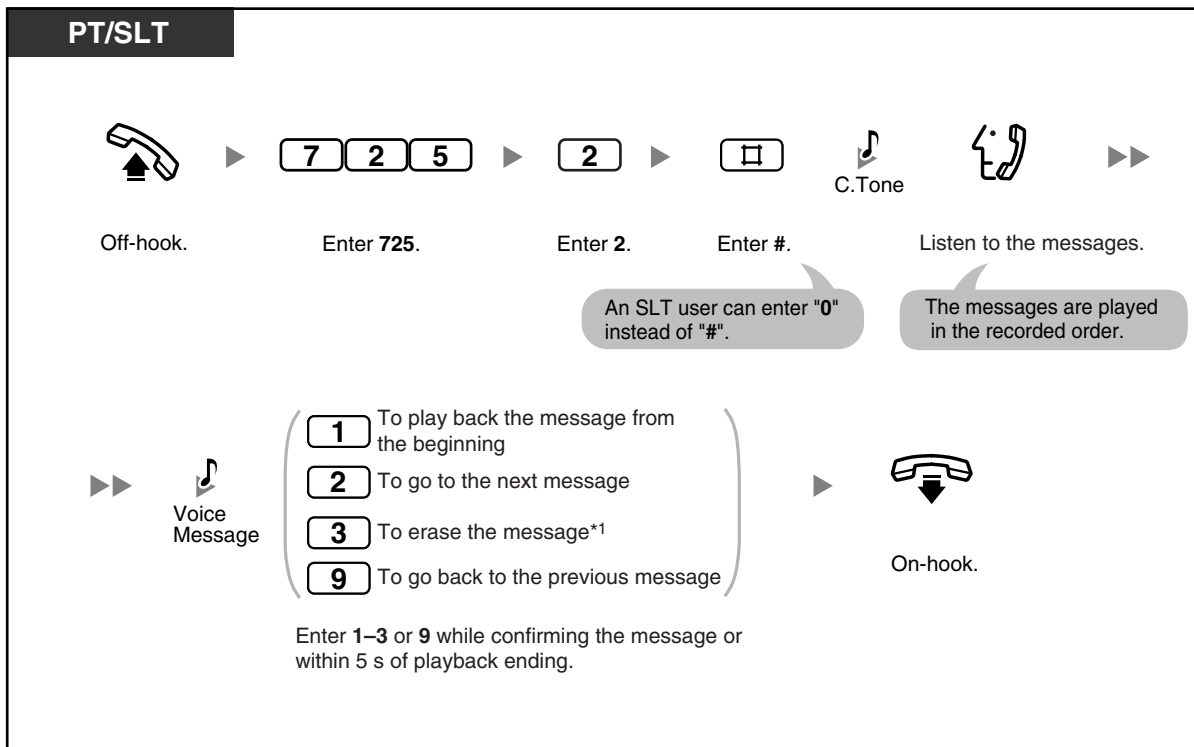

To erase all voice messages in a voice message area

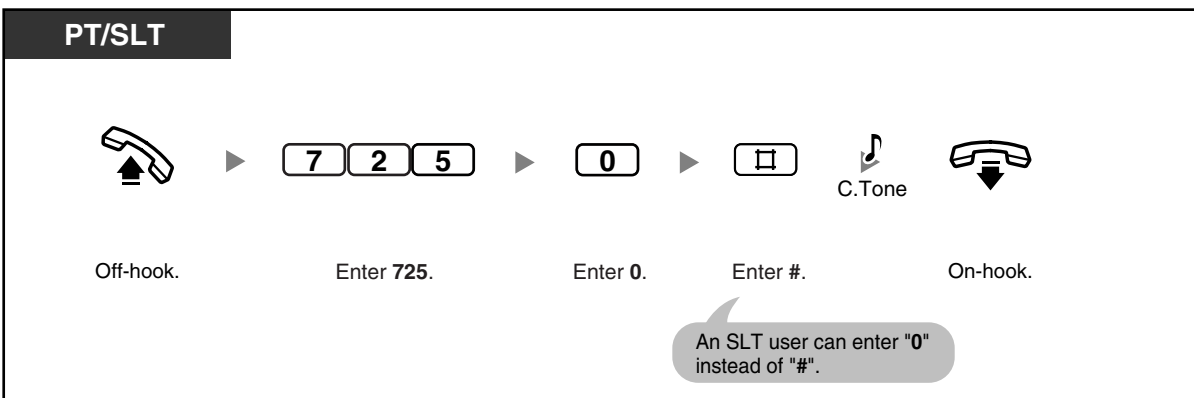

To play back and/or erase voice messages from an outside telephone

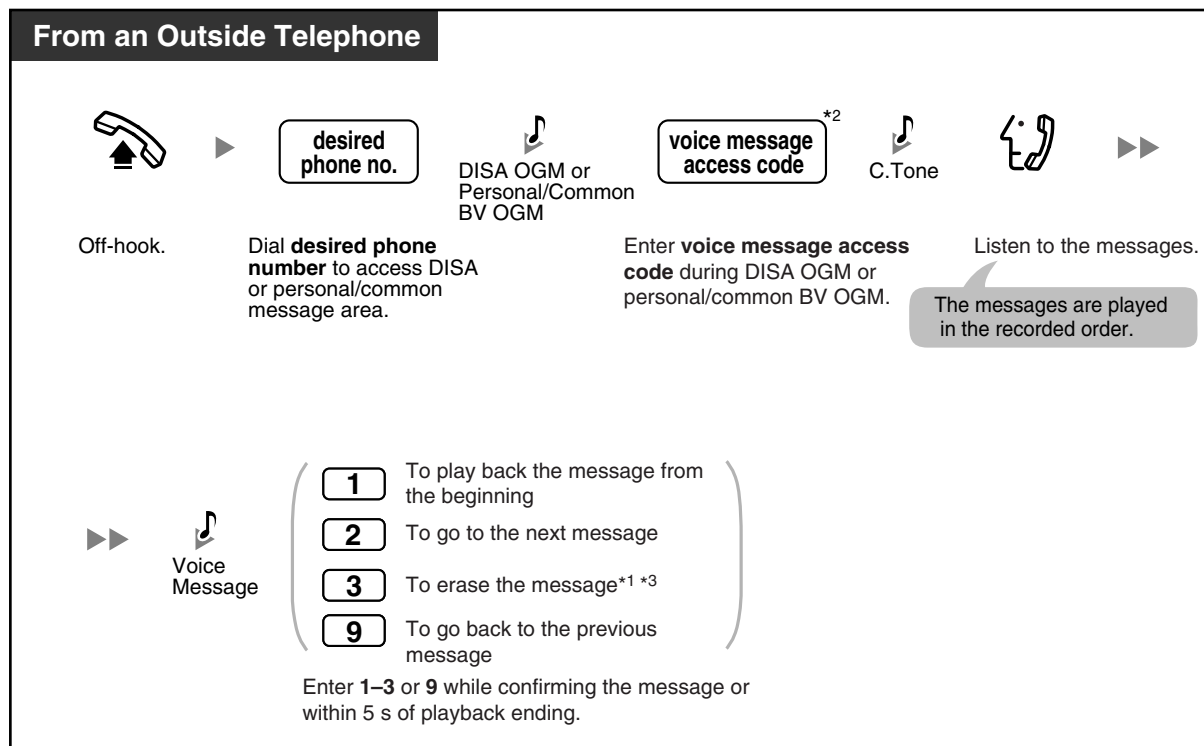

- *1 To erase a voice message while listening to the message, enter "3". You will hear dial tone 3. Enter "3" again to erase the message. If you change your mind and decide not to erase the message, dial another number ("1", "2", or "9") or go on-hook while hearing dial tone 3.
- *2 For a directed call to an extension (forwarded to the extension's message area), that extension's voice message access code must be entered. While hearing the common BV OGM, the operator/manager's voice message access code must be entered.
- *3 When you are calling from an outside telephone, after hearing dial tone 3 for 5 seconds, the next message is automatically played back. You can dial any function number ("1", "2", "3", or "9") while confirming any message.



- Callers cannot put a call on hold by pressing the TRANSFER or HOLD button while recording a voice message.
- If you enter a wrong voice message access code, when trying to play back voice messages from an outside telephone, the call will be disconnected after 10 seconds. When playback is complete, or you have no voice messages recorded, the call will be disconnected after 5 seconds.
- When you erase voice messages, the caller's information is erased simultaneously.
- The MESSAGE button light or Message/Ringer Lamp shows the current status of the voice message area as follows:
 - Off:** No voice messages, or old voice messages only
 - Red on:** New voice messages
 If your telephone has no MESSAGE button or Message/Ringer Lamp, you cannot tell by looking whether there are new voice messages.

- If a new voice message has been recorded, you will hear dial tone 4 when going off-hook.

Dial Tone 4



- When the remaining recording time for the PBX is less than 5 minutes or when 125 voice messages have been recorded, the display informs you that the voice message area is full, and you hear dial tone 5 when going off-hook. If the remaining recording time goes back to being 5 minutes or more, for example, when messages are erased, the display returns to the idle status display and you will hear another dial tone instead of dial tone 5 when going off-hook.

Dial Tone 5



- A proprietary telephone (PT) user can listen to voice messages by entering the Message Waiting Answer feature number, "784# (7840)".
- You can lock your extension so that other people cannot access the personal/common message area using your telephone. Refer to "1.3.44 Extension Lock".



Programming Manual References

[PT Programming]

- [214] BV Recording Time
- [215] Common/Personal BV OGM Recording Time
- [414-416] CO Line Mode—Day/Night/Lunch
- [438-440] DISA IRNA to BV—Day/Night/Lunch
- [621] BV Resource
- [622] BV for Extension
- [625] BV Access Code through CO Line
- [807] BV Total Recording Time
- [808] BV Card Initialization
- [963] Call Forwarding Selection
- [999] System Data Clear

[PC Programming]

- 8.4 System Data Clear
- 8.6 BV Card Initialization
- 9.2.1 Main [2-1]—FWD Selection
- 9.3.1 Line Mode [3-1]—Mode of incoming CO calls—Day, Night, Lunch
- 9.8 BV [8]

Feature Manual References

- 1.1.8 Built-in Voice Message (BV)

Operating Manual References

- 1.3.18 Call Log, Incoming
- 1.3.34 Direct Inward System Access (DISA)
- 1.3.44 Extension Lock
- 3.1.3 Flexible Button Assignment
Create or edit a Message button, Caller ID Indication—Personal button, or Caller ID Indication—Common button.

1.3.8 Busy Station Signaling (BSS)

If the extension that you want to call is busy, you can send a call waiting tone, to inform the extension user that your call is waiting. When the extension user hears this tone, he or she can choose to put the current party on hold, and talk to you.

PT/SLT

While hearing a busy tone after dialing an extension number

1

Enter 1.



- **If you hear a reorder tone after dialing an extension number**, this feature is not available for the other party's phone. This feature is only available if the called extension has set Call Waiting. To set Call Waiting or to answer a waiting call, refer to "1.3.28 Call Waiting".



Feature Manual References

- 1.1.9 Busy Station Signaling (BSS)

Operating Manual References

- 1.3.28 Call Waiting

1.3.9 Call Forwarding (FWD)—SUMMARY

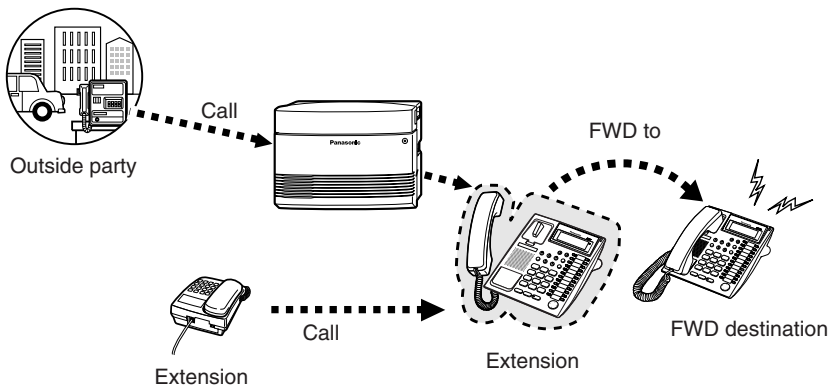

You can have your incoming calls forwarded to a specified destination. The following methods are available:

All Calls:

All calls are forwarded to a specified extension regardless of the status of your extension.

Busy/No Answer (BSY/NA):

All calls are forwarded to a specified extension when you do not answer within a specified time period or when your extension is busy.

Follow Me (From):

If you fail to set the above-mentioned "All Calls" to forward before you leave your desk, you can set your calls to be forwarded from the destination extension.

To Outside (CO) Line:

All calls are forwarded to an outside party if your extension is permitted through system programming. The call duration is limited.



- The FWD/DND button light shows the current status as follows:
 - Off:** Neither feature is set.
 - Red on:** Do Not Disturb (DND) mode
 - Flashing red slowly:** Call Forwarding (FWD) mode
- If a proprietary telephone (PT) user sets the FWD—Busy/No Answer feature, the FWD/DND button light will keep flashing while on-hook. To stop the button from flashing, go off-hook and enter "716#".
- A call can only be automatically forwarded one time. In the example below, extension A's calls are being forwarded to extension B. If extension B tries to set FWD to extension C, the extension B user hears a reorder tone and the setting is denied. If extension B has already set FWD to extension C, and extension A tries to set FWD to extension B, the setting is also denied.

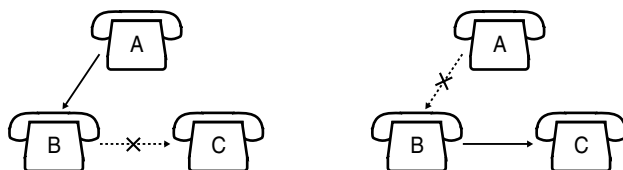

- You can confirm the current FWD destination by pressing the FWD/DND button while on-hook.



- You can set the voice mail extension number as the FWD destination to receive calls into your mailbox.
- You can set the Built-in Voice Message (BV) feature number as the FWD destination to receive calls into one of the voice message areas.
- The destination of an extension's forwarded calls can call or transfer calls to the original extension.

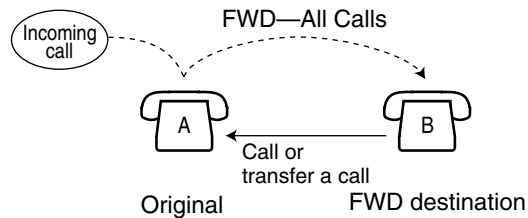

Programming Manual References

[PC Programming]

- 9.2.2 Feature settings [2-2]—FWD/DND

Feature Manual References

- 1.1.10 Call Forwarding (FWD)—SUMMARY

Operating Manual References

- 1.3.7 Built-in Voice Message (BV)
- 1.3.14 Call Forwarding (FWD)—CANCEL
- 1.3.35 Do Not Disturb (DND)
- 1.3.88 Voice Mail Integration
- 3.1.3 Flexible Button Assignment
Create or edit an FWD/DND (Call Forwarding/Do Not Disturb).

1.3.10 Call Forwarding (FWD)—All Calls

You can forward all calls to another extension.

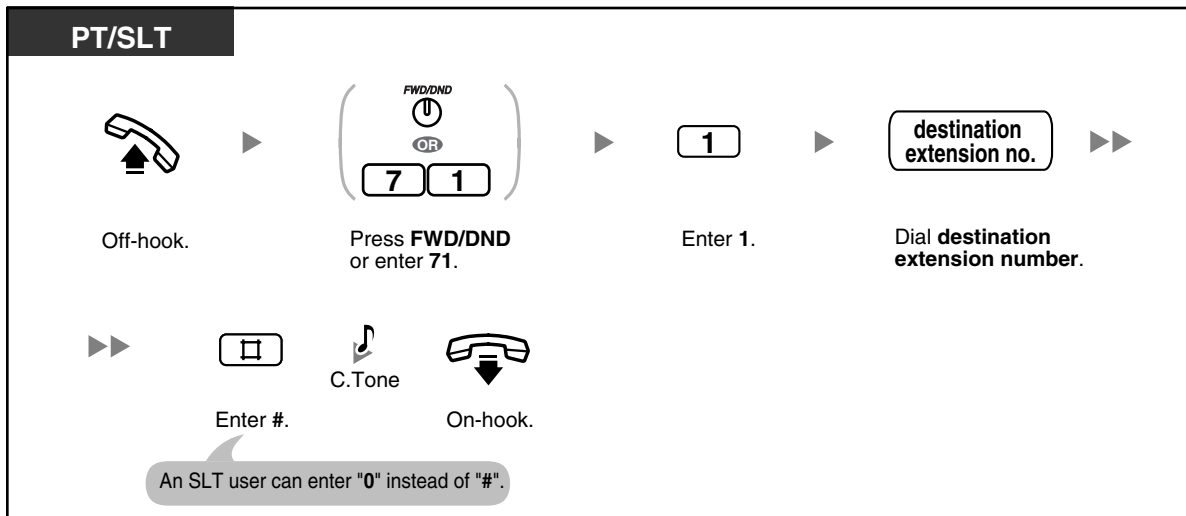

Feature Manual References

- 1.1.11 Call Forwarding (FWD)—All Calls

1.3.11 Call Forwarding (FWD)—Busy/No Answer

You can forward your calls to another extension when you do not answer within a specified time period or when your extension is busy.

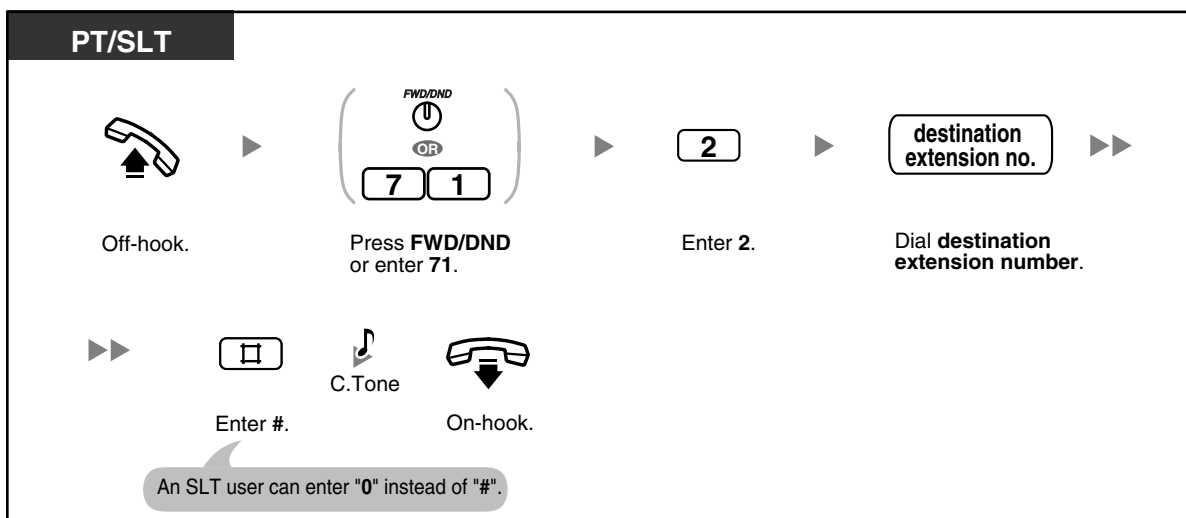

Programming Manual References

[PT Programming]

- [202] Call Forwarding Start Time

[PC Programming]

- 9.1.7 Timers [1-6]—Start Time—Call Forwarding

Feature Manual References

- 1.1.12 Call Forwarding (FWD)—Busy/No Answer

1.3.12 Call Forwarding (FWD)—Follow Me

You can set your calls to be forwarded from the destination extension. This is useful if you forget to set "Call Forwarding (FWD)—All Calls" before you leave your desk.

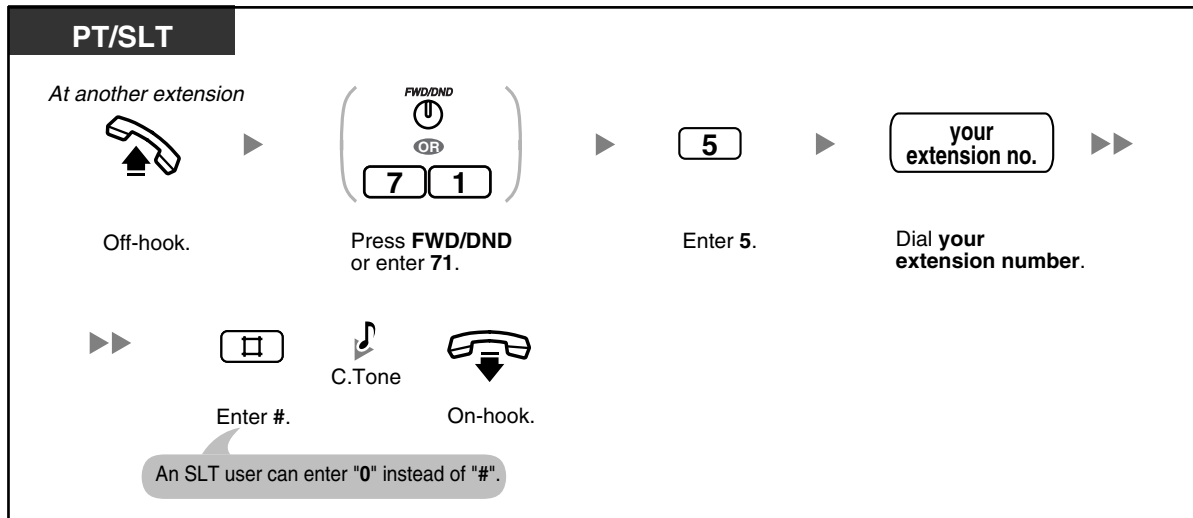

- This feature can be canceled at your (original) extension or at another (destination) extension.



Feature Manual References

- 1.1.13 Call Forwarding (FWD)—Follow Me

1.3.13 Call Forwarding (FWD)—To Outside (CO) Line

You can forward all calls to an outside party if your extension is permitted through system programming.

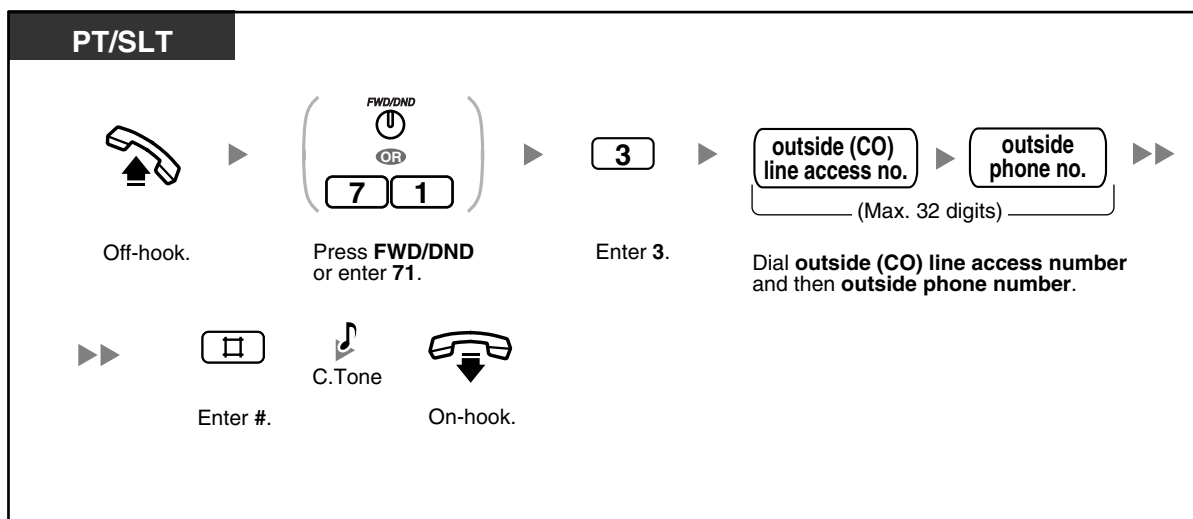



- CO-to-CO Line Call Duration**
 The length of outside-to-outside (CO-to-CO) line calls may be limited through system programming. Both the outside caller and the outside destination will hear a warning tone 15 seconds before a specified time limit. When the timer expires, the call is disconnected.
- An account code must be entered by pressing the "× ×" key and entering the account code after the outside (CO) line access number in Account Code—Verify-All/Forced mode.

Programming Manual References

[PT Programming]

- [205] CO-to-CO Line Call Duration
- [414-416] CO Line Mode—Day/Night/Lunch
- [605] Account Code Mode
- [607] Call Forwarding to CO Line

[PC Programming]

- 9.1.7 Timers [1-6]—Call Duration—CO-to-CO Duration Limit
- 9.2.1 Main [2-1]—Account Code Mode, Call Forward to CO
- 9.3.1 Line Mode [3-1]—Mode of incoming CO calls—Day, Night, Lunch

Feature Manual References

- 1.1.14 Call Forwarding (FWD)—To Outside (CO) Line

1.3.14 Call Forwarding (FWD)—CANCEL

You can cancel Call Forwarding (FWD) at your (original) extension or at another (destination) extension.

To cancel at your extension

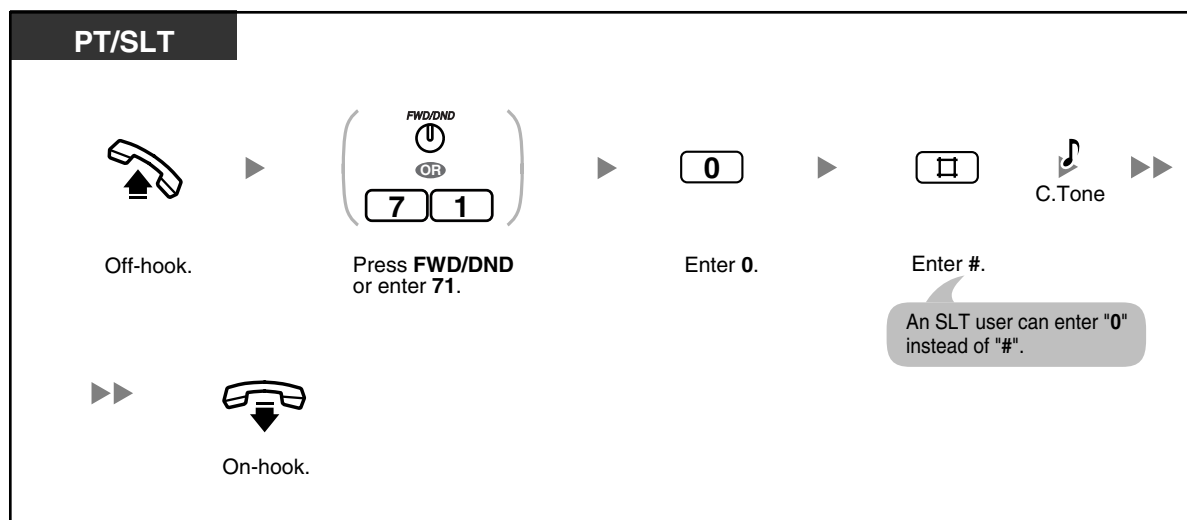

To cancel at another extension ("FWD—Follow Me" only)

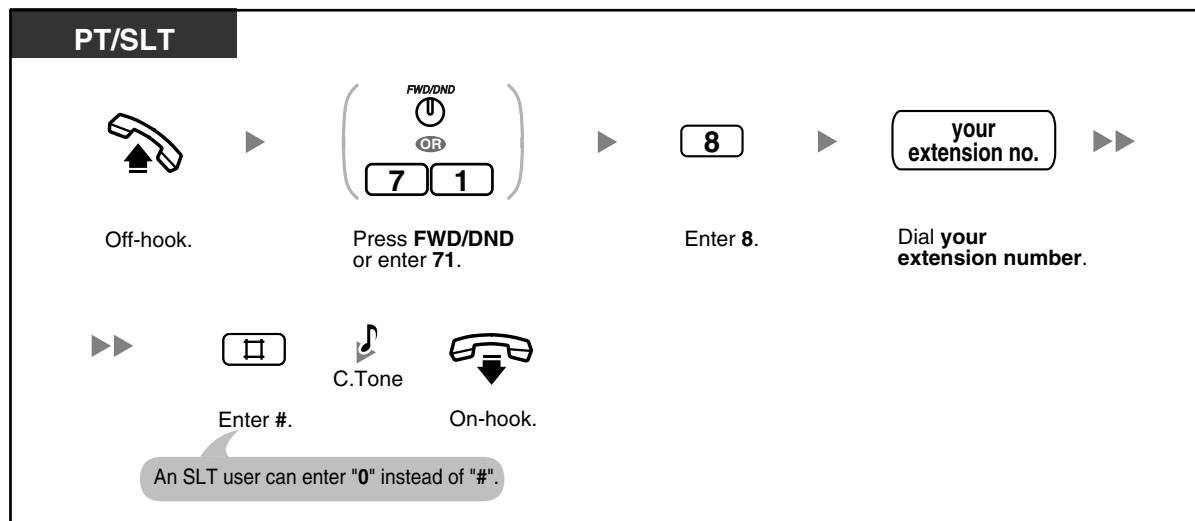

Feature Manual References

- 1.1.10 Call Forwarding (FWD)—SUMMARY

1.3.15 Call Hold

You can place a call on hold.

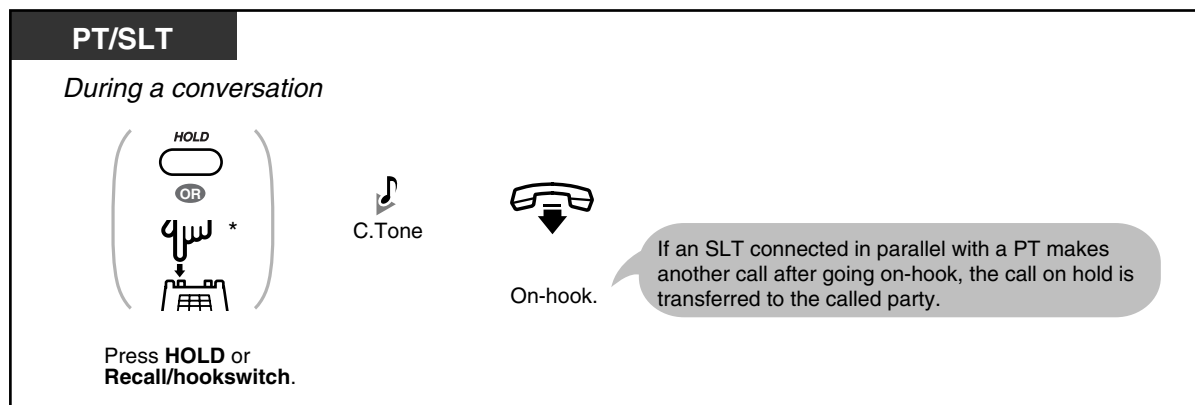

- * You may have to enter the Call Hold feature number, "20", after pressing the Recall/hookswitch on your single line telephone (SLT), depending on the SLT Hold Mode of your PBX. For more details, refer to "1.1.15 Call Hold" in the Feature Manual.
- **Hold Mode Change (proprietary telephone [PT] only)**
Pressing the HOLD button again while a call is on hold switches the status from General Call Hold mode to Exclusive Call Hold mode, or vice versa.
- You cannot hold doorphone calls.
- **If a call is not retrieved within a specified time period**, you will hear a ring tone. If you are having a conversation with another party at that time, you will hear an alarm tone. If an outside (CO) line call is not retrieved within 30 minutes of being put on hold, it will be automatically disconnected.



- There are 2 types of Call Hold mode. The difference between them is whether other people can retrieve the held call (Call Hold) or not (Call Hold, Exclusive).
- An SLT user can hold either one intercom call or one outside (CO) line call at a time, while a PT user can hold one intercom call and multiple outside (CO) line calls. To hold multiple calls, use the Call Park feature.



Programming Manual References

[PT Programming]

- [104] SLT Hold Mode
- [111] Music on Hold
- [200] Hold Recall Time

[PC Programming]

- 9.1.2 Main [1-2]—Music on Hold
- 9.1.7 Timers [1-6]—Recall Time—Call Hold
- 9.1.11 Detail [1-10]—Single Line Telephone—Hold Mode

Feature Manual References

- 1.1.15 Call Hold

Operating Manual References

- 1.3.17 Call Hold Retrieve
- 1.3.20 Call Park

1.3.16 Call Hold, Exclusive

You can prevent other extension users from retrieving your held call. Only the proprietary telephone (PT) user who held the call can retrieve it.



No SLT

PT

During a conversation



C.Tone

Press **HOLD**.



D.Tone

Press **HOLD** again.



On-hook.



- **Hold Mode Change (PT only)**
Pressing the HOLD button again while a call is on hold switches the status from General Call Hold mode to Exclusive Call Hold mode, or vice versa.
- **If a call is not retrieved within a specified time period**, you will hear a ring tone. If you are having a conversation with another party at that time, you will hear an alarm tone. If an outside (CO) line call is not retrieved within 30 minutes of being put on hold, it will be automatically disconnected.



- There are 2 types of Call Hold mode. The difference between them is whether other people can retrieve the held call (Call Hold) or not (Call Hold, Exclusive).
- A PT user can hold one intercom call and multiple outside (CO) line calls. To hold multiple intercom calls, use the Call Park feature.



Programming Manual References

[PT Programming]

- [111] Music on Hold
- [200] Hold Recall Time

[PC Programming]

- 9.1.2 Main [1-2]—Music on Hold
- 9.1.7 Timers [1-6]—Recall Time—Call Hold

Feature Manual References

- 1.1.16 Call Hold, Exclusive

Operating Manual References

- 1.3.17 Call Hold Retrieve
- 1.3.20 Call Park

1.3.17 Call Hold Retrieve

You can retrieve a call that has been put on hold at the holding extension or by another extension.

PT/SLT

● At the holding extension

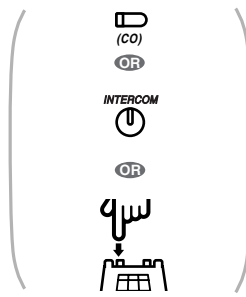

▶



Press flashing **CO** or **INTERCOM**.
Or press **Recall/hookswitch**. Talk.

If the handset has been replaced, just go off-hook.
(SLT only, excluding an SLT in parallel with a PT)

● To retrieve an outside (CO) line call put on hold (General Call Hold) by another extension



▶

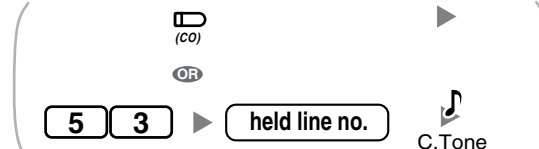

▶



Off-hook. Press **CO**, or enter **53** and then dial **held line number**. C.Tone Talk.

● To retrieve an intercom call put on hold (General Call Hold) by another extension



▶

5

▶

holding extension no.

▶





Off-hook. Enter **5**. Dial **holding extension number**. C.Tone Talk.



- The CO or INTERCOM button light shows the current status as follows:
 - General Call Hold mode
 - Flashing green slowly:** You have a call on hold.
 - Flashing red slowly:** Another extension has a call on hold.
 - Exclusive Call Hold mode
 - Flashing green at moderate speed:** You have a call on hold.
 - Red on:** Another extension has a call on hold.
- Call Park and Call Hold, Exclusive cannot be retrieved by this feature.
- You hear a confirmation tone when the call on hold is retrieved by entering the Call Hold Retrieve feature number.



Feature Manual References

- 1.1.17 Call Hold Retrieve

Operating Manual References

- 1.3.15 Call Hold
- 1.3.16 Call Hold, Exclusive
- 1.3.20 Call Park

1.3.18 Call Log, Incoming

If your PBX receives caller information from the telephone company (phone number and/or caller name), the PBX automatically logs this information each time you do not answer an outside (CO) line call. You can view a log of unanswered calls later to see who called and when, and use this information to call back the callers.

There are 2 types of call log areas available in the PBX. One is the personal area, which logs calls for each extension separately. The other is the common area, which logs calls to multiple extensions and calls via Direct Inward System Access (DISA) Intercept Routing. Up to 20 calls can be logged in each personal area and up to 300 calls in the common area.

When the call log in the personal area is full, new calls can either be disregarded or can overwrite the oldest calls that have already been viewed in the personal area call log. Similarly, when the call log in the common area is full, new calls can either be disregarded or can overwrite the oldest calls that have already been viewed in the common area call log. For more details, refer to "2.1.8 The 301st Call Log, Incoming in the Common Area Treatment".

Voice messages recorded by Built-in Voice Message (BV) are stored separately from caller information. However, when a caller leaves a voice message, it is automatically linked to the caller information in the Incoming Call Log. Up to 125 voice messages can be logged. For more details, refer to "1.3.7 Built-in Voice Message (BV)".

You can also set caller information to be automatically logged into your personal area or the common area even when you answer an outside (CO) line call.

Additionally, logged phone numbers can be edited so that you can call callers back without worrying about outside (CO) line access numbers, area codes, etc.

The following information is logged:

- Caller's Phone Number & Name
- Date/Time of receiving call
- Voice Message (if stored)

To check the number of logged calls

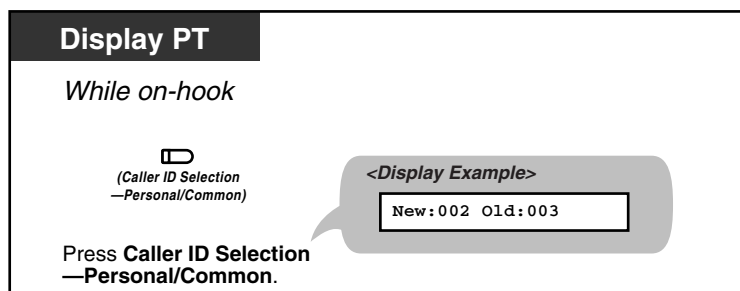



- **New:** Call records that have not previously been viewed
Old: Call records that have previously been viewed
 Both new and old call records are stored in each personal and common area.
- Since the status of call records is always shown on the bottom of a proprietary telephone (PT) with a 3-line display such as the KX-T7736, pressing the Caller ID Selection—Personal/Common button while on-hook is not necessary. If both a Caller ID Selection—Personal button and a Caller ID Selection—Common button are assigned to a PT, the status of call records of the Caller ID Selection—Common button are shown on the display while on-hook.

To view caller information and call back a caller

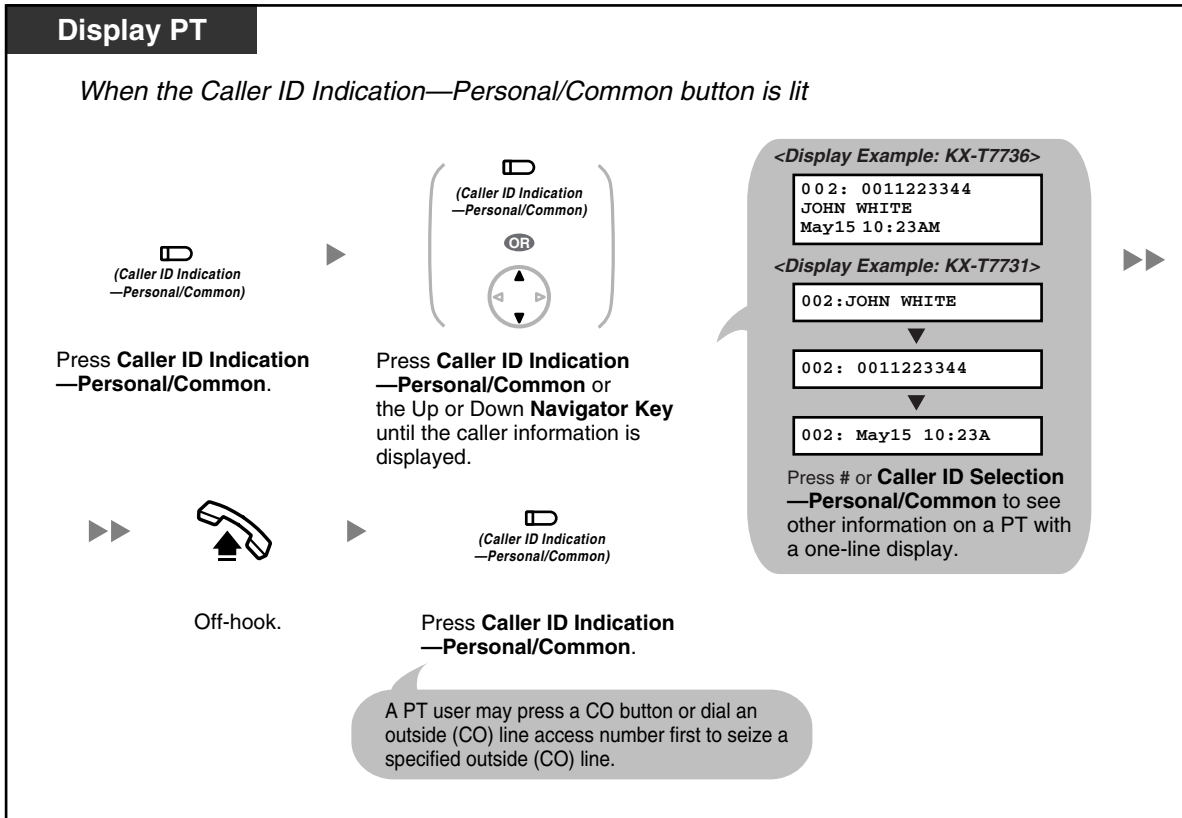

To erase caller information

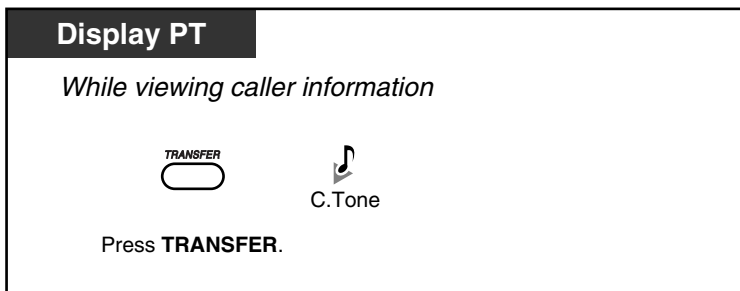



- If the Call Waiting Caller ID feature is enabled for one or more outside (CO) lines, the sequence number such as "002:" will be deleted and subsequent information (Caller's number, etc.) will be moved to the left side of the display.
- Only 12 digits (or characters) of a caller's number (or name) can be displayed even though up to 16 digits (or characters) of information can be received. To scroll the display, press the FWD/DND (Call Forwarding/Do Not Disturb) button.
- To return to the idle status display, go off-hook and then on-hook. The display also returns to the idle status display automatically if no operation is performed for 20 seconds.
- To modify the logged telephone number, press the HOLD button to erase digits and then use 0 to 9, *, and PAUSE to add numbers in front of the first digit.

To view caller information and play back an associated voice message in a voice message area

Display PT

*While viewing caller information with an associated voice message
(When the Message/Ringer Lamp or the MESSAGE button is lit)*



Press **MESSAGE**.



C.Tone



Listen to the message.

To erase caller information, including associated voice message in a voice message area

Display PT

*While viewing caller information or
after playing back the associated voice message*



Press **TRANSFER**.





Press **TRANSFER** again to
confirm the deletion.



C.Tone

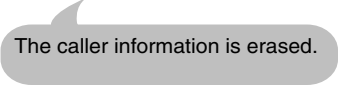

The caller information is erased.

To erase all caller information in the personal area

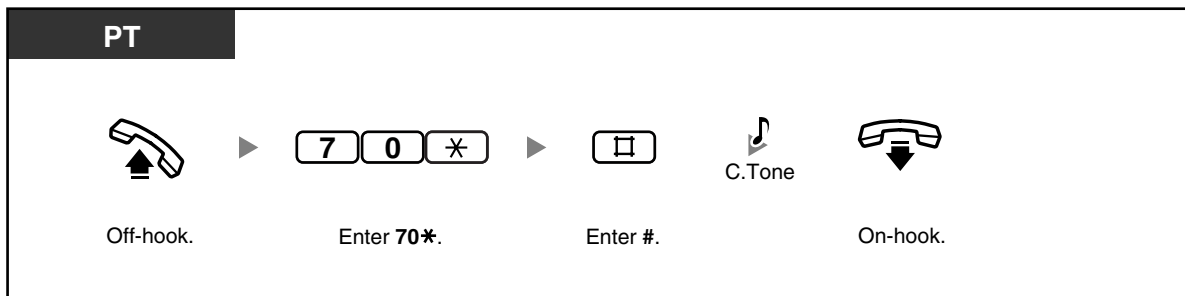

- Caller information with associated voice messages is not erased by this operation.
- To erase all caller information in the common area, refer to "2.1.1 Call Log, Incoming in the Common Area—CLEAR ALL".

To disregard the newest call/overwrite the oldest call in the personal area call log

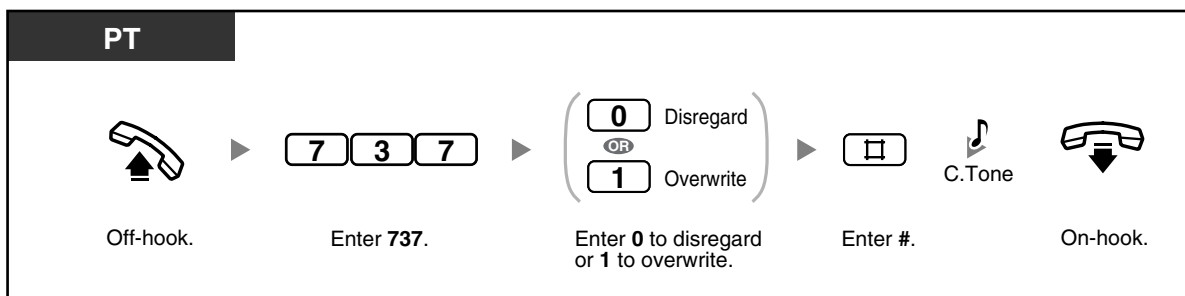

To set/cancel logging of caller information when answering a call

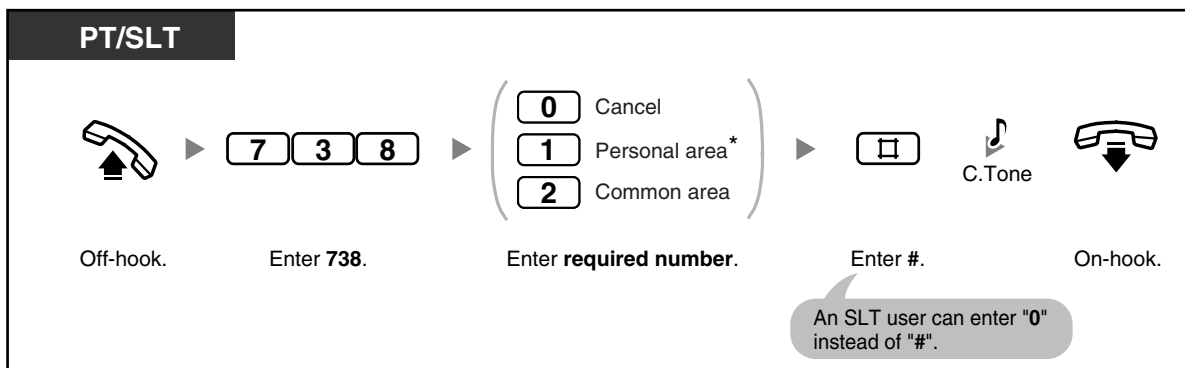

- If you press the Caller ID Indication—Personal/Common button during a conversation, the caller's information is logged regardless of this setting.
- You can set logging of caller information in both the personal area and the common area at the same time.
- * When using a single line telephone (SLT), except for an SLT connected in parallel with a PT, you cannot log caller information in the personal area.
- New information of calls that you did not answer will be displayed first.
- Information of answered calls is logged as old (already viewed) information.



- A Caller ID Indication—Personal/Common button can be used to:
 - Inform you of calls logged in your personal area or the common area,
 - Store the information of an incoming call during a conversation, and
 - View caller information while on-hook and call back a caller whose information is stored in your personal area or the common area.
- A Caller ID Selection—Personal/Common button can be used to:
 - Display and cycle through the information of an incoming call during a conversation, while receiving a call, or while viewing caller information,
 - Display the number of logged calls while on-hook, and
 - Inform you that the personal or common area call log is full.
- If a Caller ID Indication—Common button is not assigned to any PT when calls arrive at multiple PTs or via the DISA Intercept Routing feature, caller information will be logged in the personal area of the PT that is connected to the lowest-numbered jack on the PBX, and a Caller ID Indication—Personal button will light.
- Even if you answer a call, you can log the caller's information by pressing the Caller ID Indication button during the conversation.
- You can lock your personal area call log (including caller information with associated voice messages) so that other people cannot access your logged information. Refer to "1.3.44 Extension Lock".
- Caller information is also logged for unscreened transferred calls, even if not answered. In this case, the caller information will be logged in the final destination's personal area.
- When viewing caller information with the Caller ID Indication—Common button, an extension user other than the operator or manager cannot play back associated voice messages in the common message area. Voice messages in the common message area can be played back or erased by the operator or manager only.
- If voice messages without caller information are recorded, "Voice Message" will be shown on a display PT instead of the caller's phone number while you are viewing caller information.
- Even if there are message waiting indications left at your extension, the Message/Ringer Lamp or the MESSAGE button light that displays notifications from the Message Waiting feature turns off while you are viewing caller information with the Caller ID Indication—Personal/Common button.
- If your telephone has no MESSAGE button, you cannot play back associated voice messages while viewing caller information.



Programming Manual References

[PT Programming]

- [900] Caller ID
- [901] Caller ID Area Code
- [902] Caller ID Modification for Local Calls
- [903] Caller ID Modification for Long-distance Calls
- [904] Caller ID Log Priority
- [906] Caller ID SMDR Format
- [907] Caller ID SMDR Printout
- [909] Common Area Call Log Check
- [913] Call Waiting Caller ID Assignment

[PC Programming]

- 9.9.1 Main [9-1]—CO Line Settings—Caller ID, CO Line Settings—Call Waiting Caller ID, Caller ID Modification—Local Area Code (for Local Call 1–5), Caller ID Modification—Removed Digits, Caller ID Modification—Added Number, Caller ID SMDR Format, Caller ID SMDR Printout
- 9.9.3 Call Log [9-3]—Caller ID Log Priority, Common Area Call Log Check, 21st Call Log in Personal Area, Call Log Answered Call

Feature Manual References

- 1.1.30 Caller ID
- 1.1.18 Call Log, Incoming
- 1.1.112 Station Message Detail Recording (SMDR)

Operating Manual References

- 1.3.7 Built-in Voice Message (BV)
- 1.3.19 Call Log Display Lock, Incoming in the Personal Area
- 1.3.44 Extension Lock
- 2.1.1 Call Log, Incoming in the Common Area—CLEAR ALL
- 2.1.2 Call Log Display Lock, Incoming in the Common Area
- 2.1.8 The 301st Call Log, Incoming in the Common Area Treatment
- 3.1.3 Flexible Button Assignment
Create or edit a Caller ID Indication—Personal button, Caller ID Indication—Common button, Caller ID Selection—Personal button, Caller ID Selection—Common button, or Message button.

1.3.19 Call Log Display Lock, Incoming in the Personal Area

You can lock your proprietary telephone (PT) so that Incoming Call Log information is not shown on the display when you press the Caller ID Indication—Personal button. This can be useful to prevent other people from viewing caller information logged in your personal area.



To lock/unlock

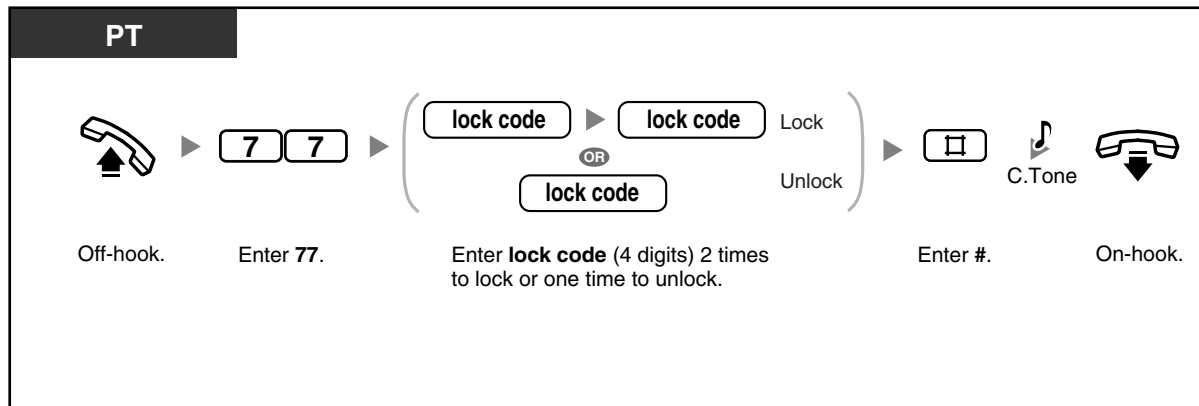

- **If you forget the code or cannot unlock your phone**, ask your operator or manager. He or she can unlock your extension (Remote Extension Lock).
- The operator or manager can cancel this feature for all extensions (Extension Lock—CANCEL ALL).
- This feature also functions as Extension Lock.



Feature Manual References

- 1.1.18 Call Log, Incoming

Operating Manual References

- 1.3.18 Call Log, Incoming
- 1.3.44 Extension Lock
- 2.1.2 Call Log Display Lock, Incoming in the Common Area
- 2.1.6 Remote Extension Lock
- 2.1.7 System Feature Assignment—Extension Lock—CANCEL ALL

1.3.20 Call Park

You can put a call on hold in a common parking zone of the PBX so that any extension can retrieve the parked call. Up to 10 calls can be parked in the PBX.

To park a call

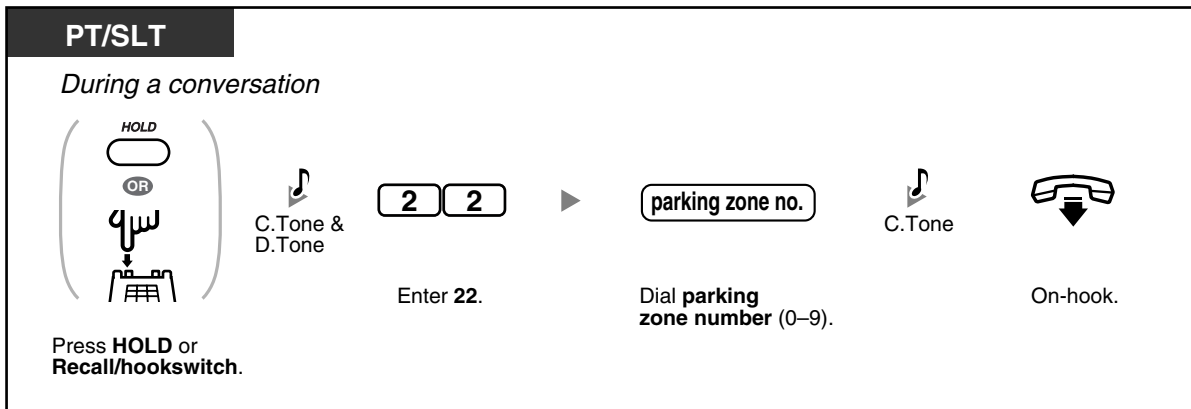

To retrieve (Call Park Retrieve)

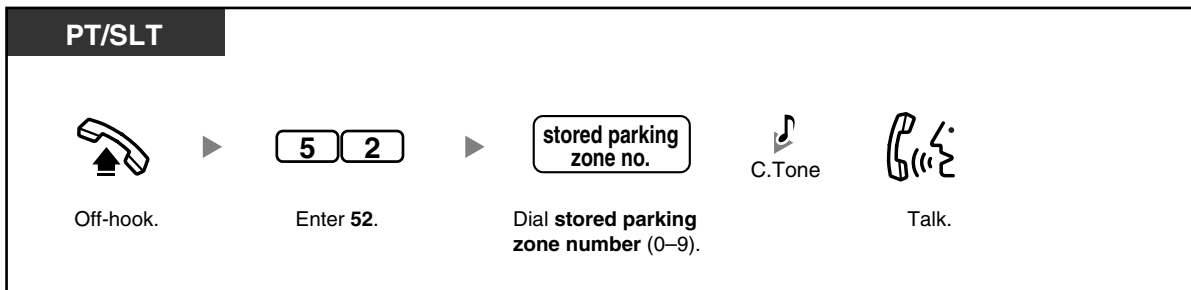

- **If a call is not retrieved within a specified time period**, you will hear a ring tone. If you are having a conversation with another party at that time, you will hear an alarm tone. If an outside (CO) line call is not retrieved within 30 minutes of being put on hold, it will be automatically disconnected.



- **If you hear a busy tone when parking a call**, the parking zone is unavailable. Dial another parking zone number directly.
- **If you hear a reorder tone when retrieving a parked call**, there is no held call in that location. Confirm the stored parking zone number.
- After you park a call, you can perform other operations.



Programming Manual References

[PT Programming]

- [200] Hold Recall Time

[PC Programming]

- 9.1.7 Timers [1-6]—Recall Time—Call Hold

Feature Manual References

- 1.1.19 Call Park

Operating Manual References

- 1.3.15 Call Hold
- 1.3.16 Call Hold, Exclusive

1.3.21 Call Pickup, Directed

Without leaving your desk, you can answer an incoming call that is ringing at another extension.

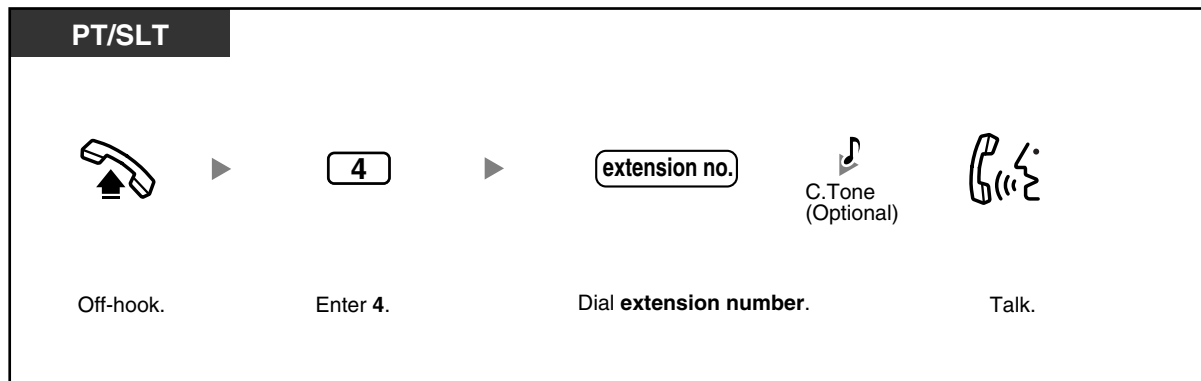

- If you hear a reorder tone when trying to pick up calls with this feature, the ringing extension has set the Call Pickup Deny feature.



Programming Manual References

[PT Programming]

- [117] Call Pickup Tone

[PC Programming]

- 9.1.11 Detail [1-10]—Extension—Call Pickup Tone

Feature Manual References

- 1.1.20 Call Pickup, Directed

Operating Manual References

- 1.3.23 Call Pickup Deny

1.3.22 Call Pickup, Group

Without leaving your desk, you can answer an incoming call that is ringing at another extension within your extension group.

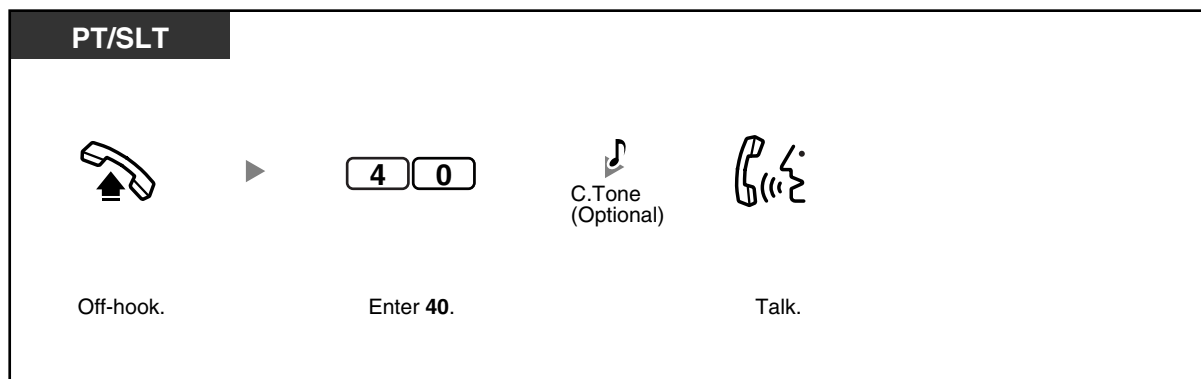



- **If you hear a reorder tone when trying to pick up calls with this feature**, the ringing extension has set the Call Pickup Deny feature.



Programming Manual References

[PT Programming]

- [117] Call Pickup Tone
- [600] Extension Group

[PC Programming]

- 9.1.11 Detail [1-10]—Extension—Call Pickup Tone
- 9.2.11 Extension Group [2-6]—Group No.

Feature Manual References

- 1.1.21 Call Pickup, Group
- 1.1.53 Extension Group

Operating Manual References

- 1.3.23 Call Pickup Deny

1.3.23 Call Pickup Deny

You can prevent other extension users from picking up your calls.

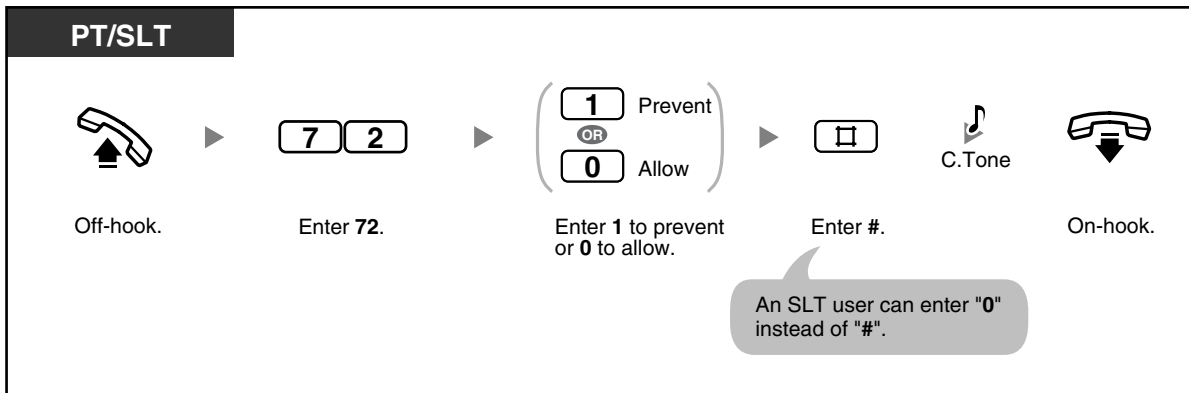

Programming Manual References

[PC Programming]

- 9.2.2 Feature settings [2-2]—Call Pickup Deny

Feature Manual References

- 1.1.22 Call Pickup Deny

Operating Manual References

- 1.3.21 Call Pickup, Directed
- 1.3.22 Call Pickup, Group

1.3.24 Call Retrieving from a TAM (Telephone Answering Machine)

Without leaving your desk, you can answer an incoming call that was received by a preprogrammed Telephone Answering Machine (TAM) extension from your phone.

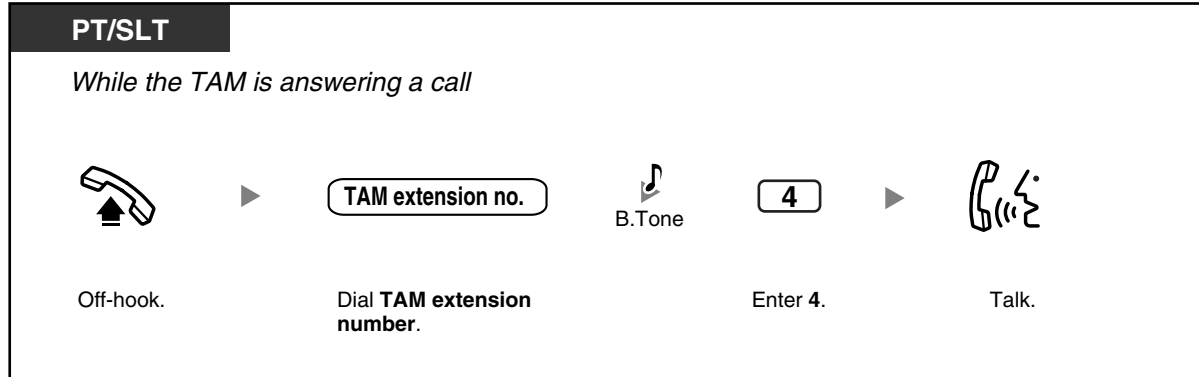

- **If you hear a reorder tone when trying to retrieve a call from a TAM**, the dialed extension is not the TAM extension, or the TAM cannot answer the call because it is performing another operation.



Programming Manual References

[PT Programming]

- [611] TAM Extension

[PC Programming]

- 9.2.1 Main [2-1]—TAM Connection

Feature Manual References

- 1.1.23 Call Retrieving from a TAM (Telephone Answering Machine)

1.3.25 Call Splitting

When talking to one party with another party on hold, you can switch between the 2 parties.

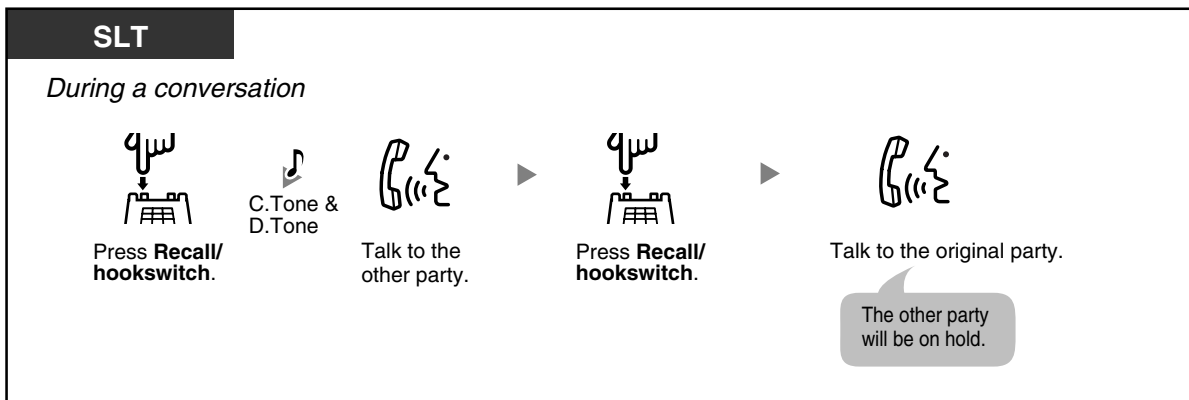
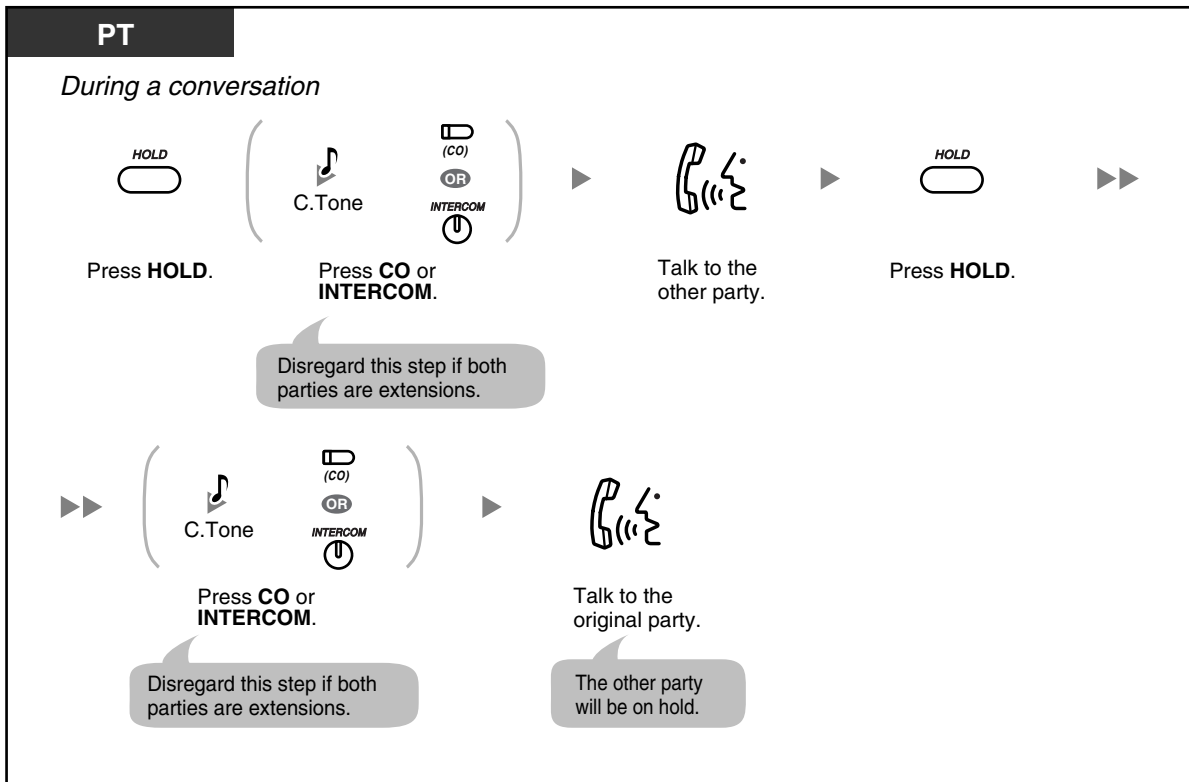

- This feature is not available for calls from doorphones or paging announcements.



Feature Manual References

- 1.1.24 Call Splitting

Operating Manual References

- 1.3.15 Call Hold
- 1.3.16 Call Hold, Exclusive

1.3.26 Call Transfer—To Extension

You can transfer incoming calls to another extension. Depending on the setting of your PBX, proprietary telephone (PT) users may also be able to transfer incoming outside (CO) line calls to another extension simply by pressing the corresponding Direct Station Selection (DSS) button (One-touch Transfer).

To transfer

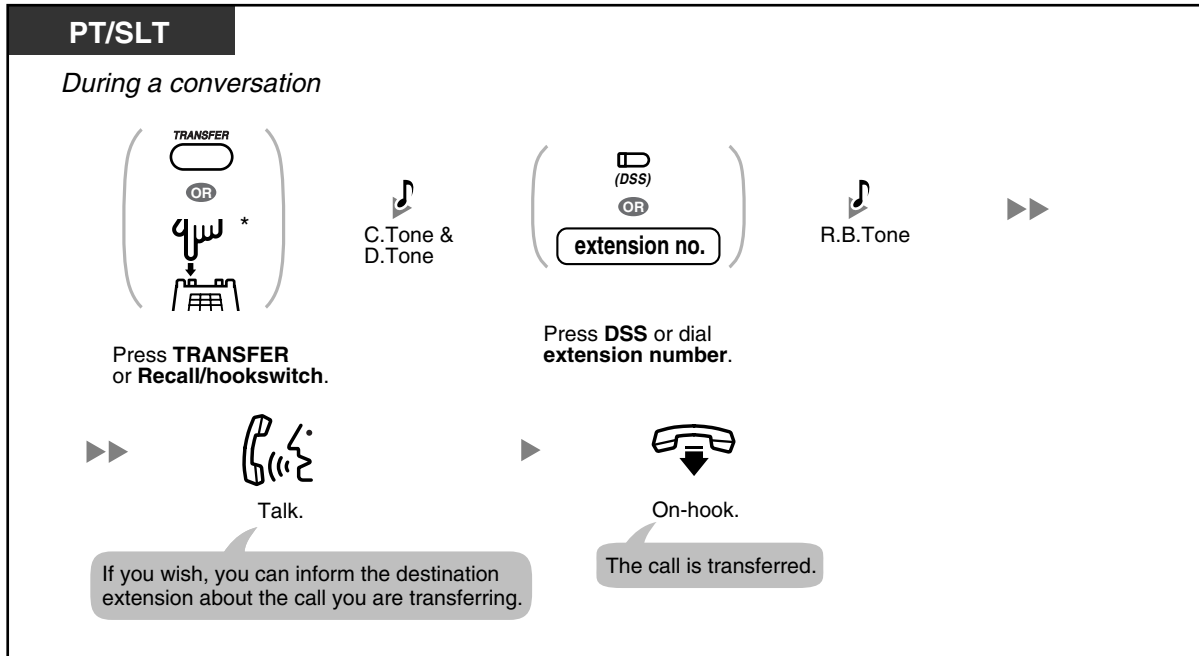

To transfer with a one-touch operation (One-touch Transfer)

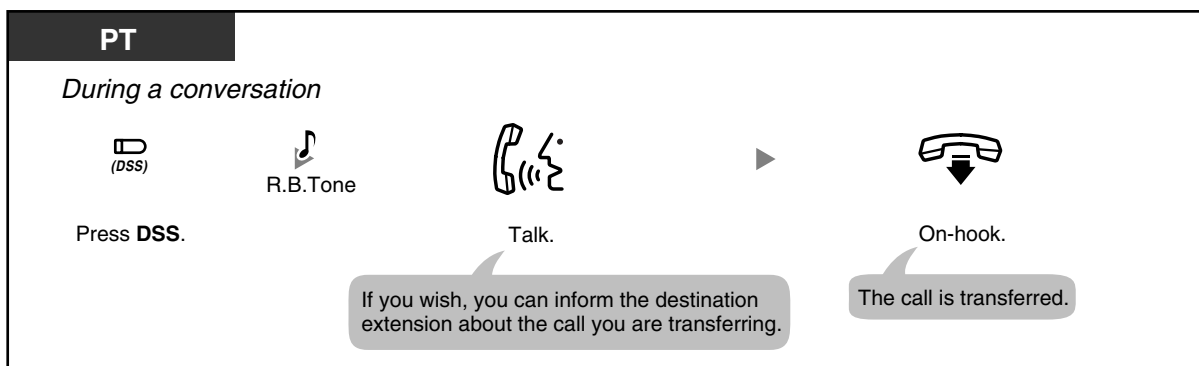



- * You may have to enter the Call Hold feature number, "20", after pressing the Recall/hookswitch on your single line telephone (SLT), depending on the SLT Hold Mode of your PBX. For more details, refer to "1.1.15 Call Hold" in the Feature Manual.
- You can go on-hook before the destination extension answers the call. If the destination extension does not answer the call within a specified time period, you will hear an alarm tone, and the call will return to you. If you do not answer the call within 30 minutes after it returns to you, the call will be disconnected.
- When the dialed extension is busy, you may access the extension by entering "1" (Busy Station Signaling [BSS]) or "2" (Executive Busy Override) and then going on-hook.
- **To return to the held call before the destination answers**, press the TRANSFER button or corresponding CO/INTERCOM button, or press the Recall/hookswitch.



Programming Manual References

[PT Programming]

- [005] One-touch Transfer Using a DSS Button
- [104] SLT Hold Mode
- [111] Music on Hold
- [201] Transfer Recall Time

[PC Programming]

- 9.1.2 Main [1-2]—Music on Hold
- 9.1.7 Timers [1-6]—Recall Time—Call Transfer
- 9.1.11 Detail [1-10]—Single Line Telephone—Hold Mode, DSS—One-touch Transfer Using a DSS Button

Feature Manual References

- 1.1.15 Call Hold
- 1.1.25 Call Transfer—To Extension

Operating Manual References

- 3.1.3 Flexible Button Assignment
Create or edit a Direct Station Selection (DSS) button.

1.3.27 Call Transfer—To Outside (CO) Line

You can transfer incoming calls to outside destination when your proprietary telephone (PT) is permitted through system programming.



No SLT

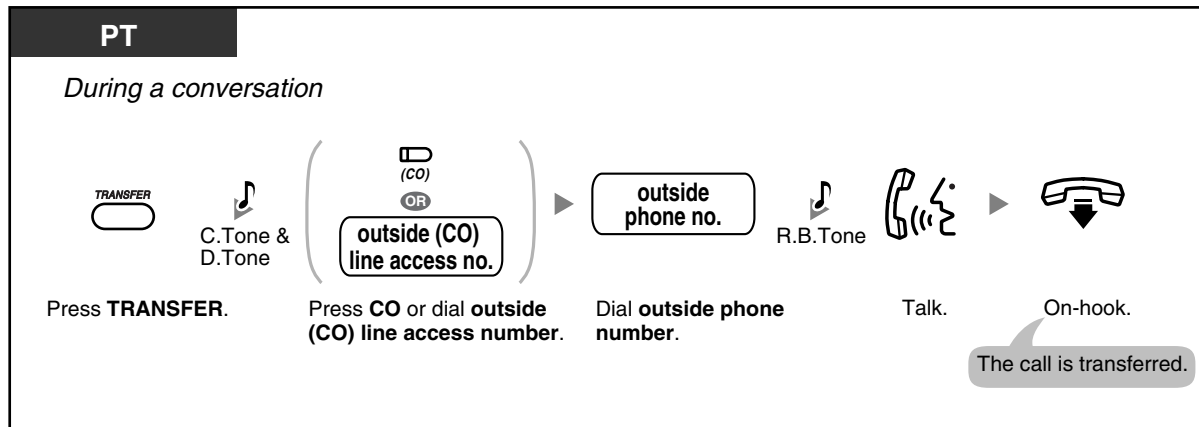

- **CO-to-CO Line Call Duration**

The length of outside-to-outside (CO-to-CO) line calls may be limited through system programming.

Both the outside caller and the outside destination will hear a warning tone 15 seconds before a specified time limit. When the timer expires, the call is disconnected.

- **To return to the held call before the destination answers**, press the TRANSFER button or corresponding CO/INTERCOM button.
- After transferring the call to an outside party, you can join the call by pressing the CO button that you used to transfer the call. A 3-party conference call is established (Conference).
- To change the transfer destination before going on-hook, press the CO button whose indicator is flashing slowly to retrieve the call, then repeat the Call Transfer procedure.



Programming Manual References

[PT Programming]

- [111] Music on Hold
- [205] CO-to-CO Line Call Duration
- [420] CPC Signal Detection—Incoming
- [606] Call Transfer to CO Line

[PC Programming]

- 9.1.2 Main [1-2]—Music on Hold
- 9.1.7 Timers [1-6]—Call Duration—CO-to-CO Duration Limit
- 9.2.1 Main [2-1]—Transfer to CO
- 9.3.3 Detail [3-3]—CPC Signal Detection—Incoming

Feature Manual References

- 1.1.26 Call Transfer—To Outside (CO) Line

Operating Manual References

- 1.3.31 Conference

1.3.28 Call Waiting

During a conversation, you can be informed of a waiting call by a tone through the built-in speaker of your proprietary telephone (PT) or the handset of your single line telephone (SLT) (Default: Disable). You can answer the second call by disconnecting the current call or placing the current call on hold.

To change the call waiting tone using your PT, refer to "3.1.2 Personal Feature Assignment—Call Waiting Tone Type Selection".

To set/cancel for outside (CO) line calls

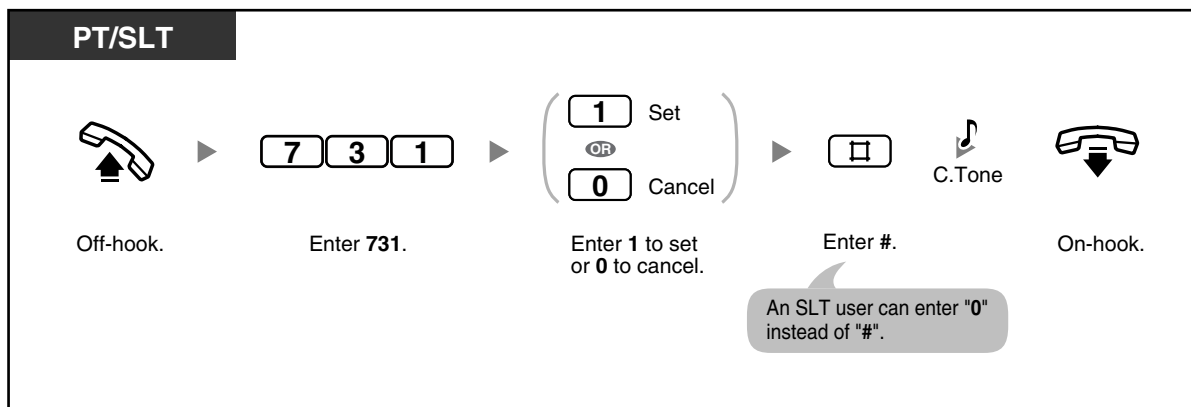

To set/cancel for intercom/doorphone calls

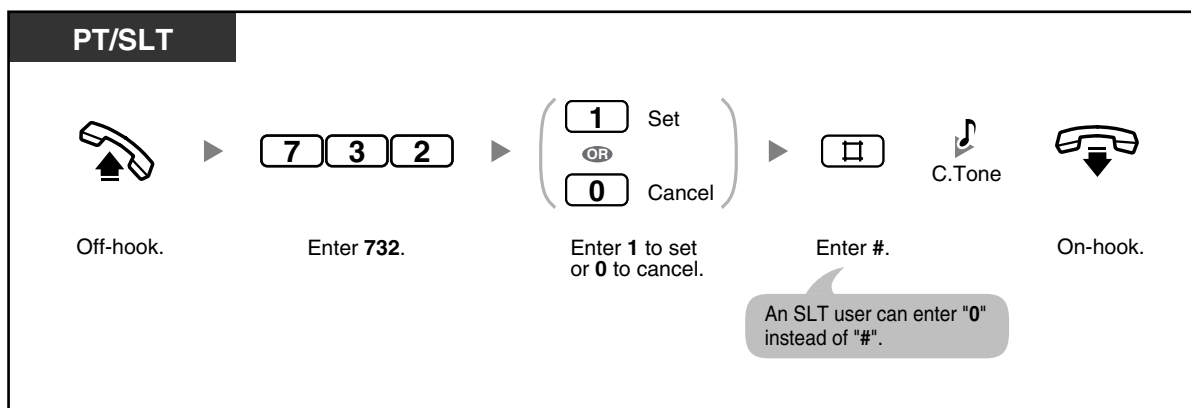

To disconnect the current call and then talk to the new party

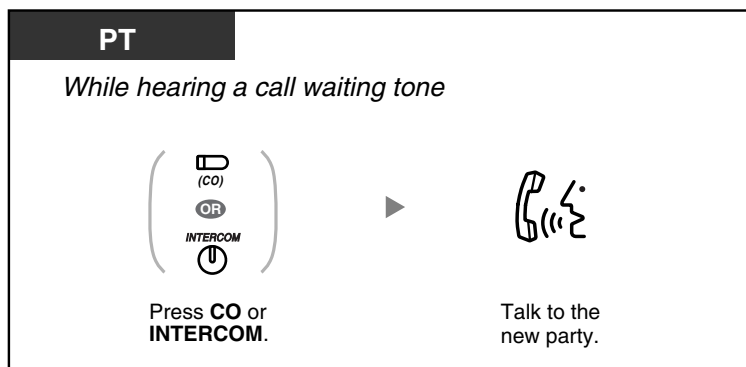



To hold the current call and then talk to the new party

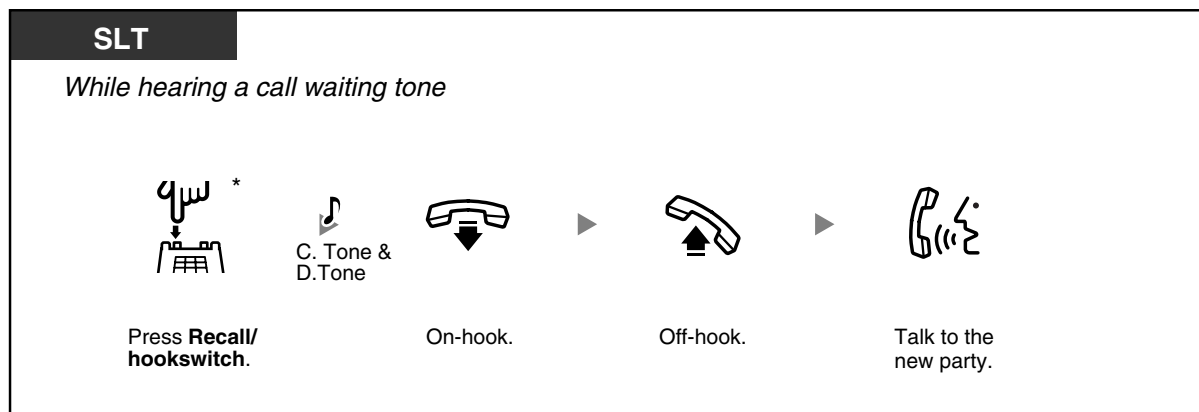
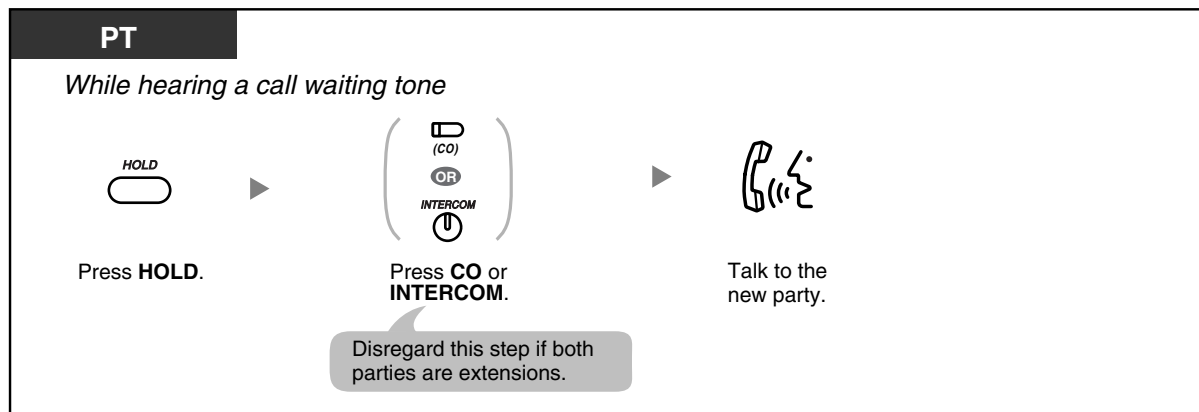

- * You may have to enter the Call Hold feature number, "20", after pressing the Recall/hookswitch on your SLT, depending on the SLT Hold Mode of your PBX. For more details, refer to "1.1.15 Call Hold" in the Feature Manual.
- An SLT user cannot transfer a new call while holding the current call. To transfer the new call, first park the original call using the Call Park feature, then go on-hook and off-hook.
- If a call waiting tone is heard but the corresponding CO button does not flash, this tone is an external call waiting tone from the telephone company. In this case, refer to "1.3.30 Call Waiting from the Telephone Company" or "1.3.45 External Feature Access (EFA)".



Programming Manual References

[PT Programming]

- [104] SLT Hold Mode
- [115] Extension Ring Tone Pattern
- [423] CO Line Ring Tone Pattern

[PC Programming]

- 9.1.11 Detail [1-10]—Extension—Ring Tone Pattern, Single Line Telephone—Hold Mode
- 9.2.2 Feature settings [2-2]—Call Waiting—intercom calls, Call Waiting—outside calls
- 9.3.3 Detail [3-3]—Ring Tone Pattern

Feature Manual References

- 1.1.15 Call Hold
- 1.1.27 Call Waiting

Operating Manual References

- 1.3.8 Busy Station Signaling (BSS)
- 1.3.20 Call Park
- 1.3.30 Call Waiting from the Telephone Company
- 1.3.33 Data Line Security
- 1.3.45 External Feature Access (EFA)
- 3.1.2 Personal Feature Assignment—**Call Waiting Tone Type Selection**

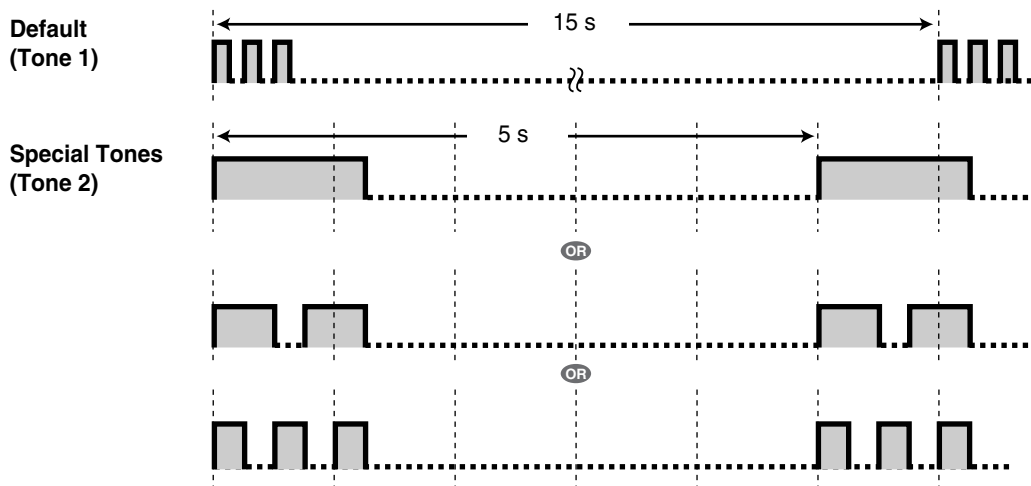

1.3.29 Call Waiting Caller ID

Your telephone company may also offer an optional call waiting service, which can inform you that you have another call on the same outside (CO) line. If Caller ID service has been contracted for, the new caller's information, such as the name and telephone number, will be displayed (flashing) on your proprietary telephone (PT) for a preprogrammed length of time. You can answer the second call by disconnecting the current call or placing the current call on hold.



To disconnect the current call and then talk to the new party

Display PT

While hearing a call waiting tone and viewing caller information



On-hook. Off-hook. Talk to the new party.

To hold the current call and then talk to the new party

Display PT

While hearing a call waiting tone and viewing caller information



Press **FLASH/RECALL**. Talk to the new party.



- **To return to the original party**, repeat the operation.
- If you do not press the FLASH/RECALL button while the information is displayed (flashing), the caller information is automatically recorded in your personal area and the Caller ID Indication—Personal button lights if the call has been directed to your PT. A call directed to multiple extensions is automatically recorded in the common area and all corresponding Caller ID Indication—Common buttons light.
- The TRANSFER button, HOLD button, and CONF button do not function while the new caller information is flashing.



Programming Manual References

[PT Programming]

- [414-416] CO Line Mode—Day/Night/Lunch
- [900] Caller ID
- [908] Call Waiting Caller ID Time
- [913] Call Waiting Caller ID Assignment
- [914] Call Waiting Caller ID CAS Receive Time
- [915] Caller ID Checksum
- [968] KX-T7700 Series Incoming Lamp Control

[PC Programming]

- 9.1.11 Detail [1-10]—Proprietary Telephone—KX-T7700 Series Incoming Lamp Control
- 9.3.1 Line Mode [3-1]—Mode of incoming CO calls—Day, Night, Lunch
- 9.9.1 Main [9-1]—CO Line Settings—Caller ID, CO Line Settings—Call Waiting Caller ID, Call Waiting Caller ID Time, Call Waiting Caller ID CAS Receive Time, Caller ID Checksum

Feature Manual References



- 1.1.28 Call Waiting Caller ID

Operating Manual References

- 1.3.18 Call Log, Incoming

1.3.30 Call Waiting from the Telephone Company

Your telephone company may also offer an optional call waiting service, which can inform you that you have another call on the same outside (CO) line. For more details, consult your telephone company.

PT	SLT
<p><i>While hearing a call waiting tone</i></p> <p>FLASH/RECALL</p>  <p>Press FLASH/RECALL.</p>	<p><i>While hearing a call waiting tone</i></p> <div style="display: flex; justify-content: space-around; align-items: center;">  <div style="text-align: center;">  <p>C. Tone & D. Tone</p> </div> <div style="border: 1px solid black; border-radius: 50%; width: 30px; height: 30px; display: flex; align-items: center; justify-content: center;">6</div> </div> <p>Press Recall/hookswitch. Enter 6.</p>



- **To return to the original party, repeat the operation.**



Programming Manual References

[PT Programming]

- [110] Flash/Recall Key Mode
- [418] Flash/Recall Time

[PC Programming]

- 9.1.11 Detail [1-10]—Proprietary Telephone—Flash/Recall Key Mode
- 9.3.3 Detail [3-3]—Flash/Recall Time

Feature Manual References

- 1.1.15 Call Hold
- 1.1.29 Call Waiting from the Telephone Company

Operating Manual References

- 1.3.45 External Feature Access (EFA)

1.3.31 Conference

You can add a third party to your conversation. A conference call can be made up of 3 extensions, one extension and 2 outside parties, or 2 extensions and one outside party.

To establish a 3-party conference call

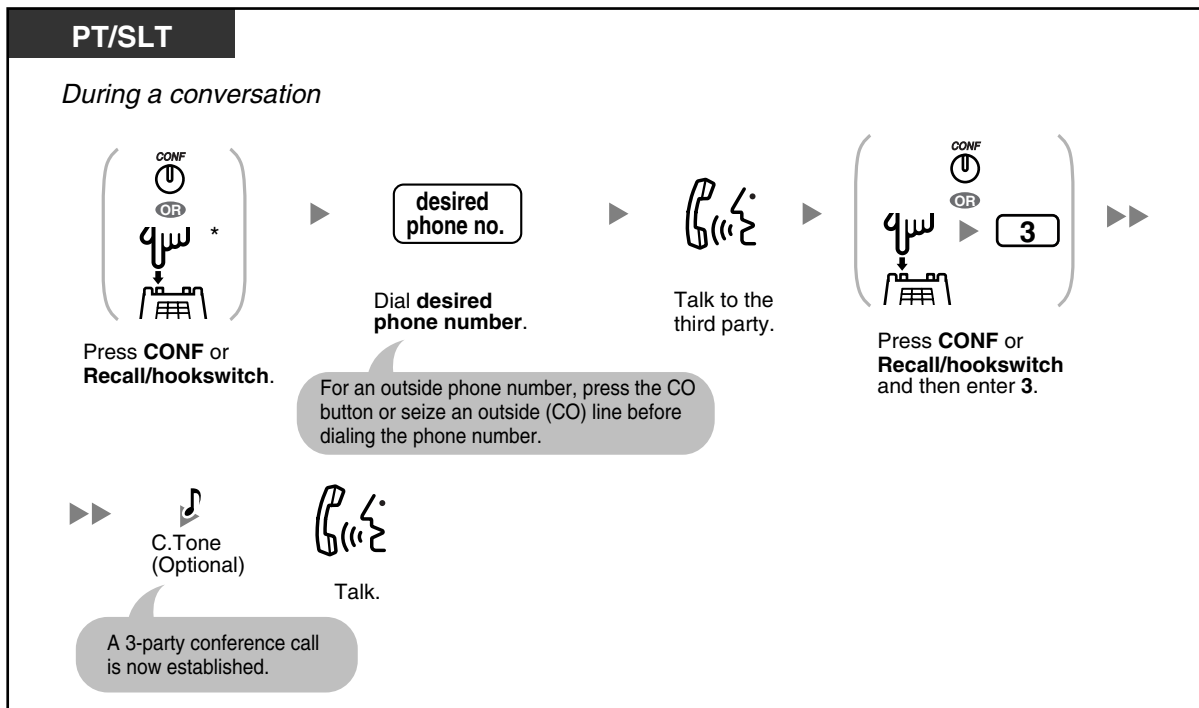

To disconnect one party and then talk to the other

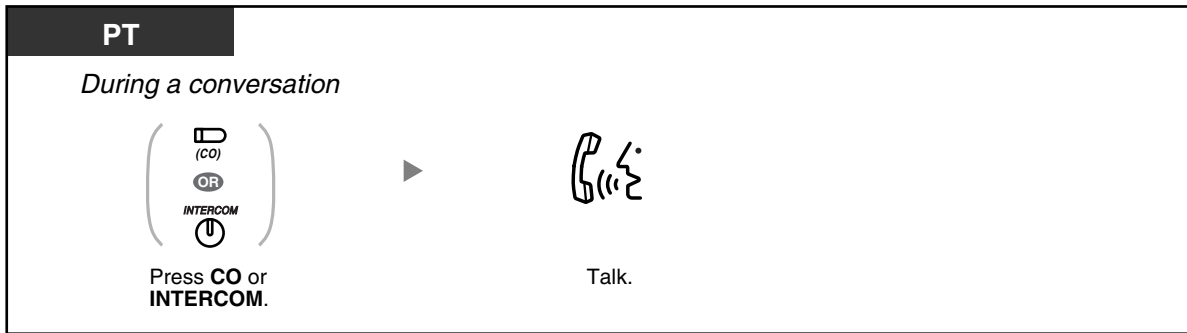

To put the third party on hold and talk to the original party

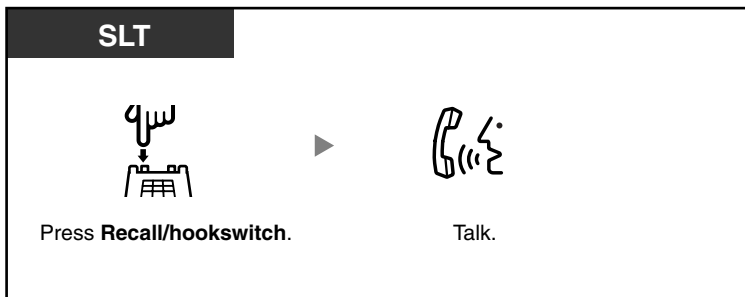

To leave a 3-party conference call

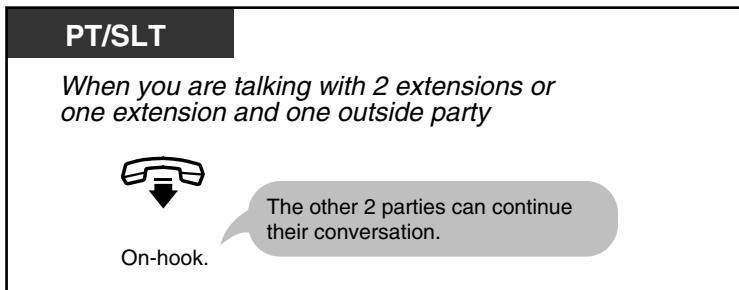

- * You may have to enter the Call Hold feature number, "20", after pressing the Recall/hookswitch on your single line telephone (SLT), depending on the SLT Hold Mode of your PBX. For more details, refer to "1.1.15 Call Hold" in the Feature Manual.
- **To return to the held call before the third party joins**, press the corresponding CO or INTERCOM button or press the Recall/hookswitch.
- By pressing the CO button corresponding to an outside (CO) line that is not being used by the conference, a proprietary telephone (PT) user can exit from the conference, leaving the other 2 parties connected unless they are both on outside (CO) lines. If the other parties are both on outside (CO) lines, they will be disconnected.



Programming Manual References

[PT Programming]

- [104] SLT Hold Mode
- [105] Conference Tone

[PC Programming]

- 9.1.11 Detail [1-10]—Single Line Telephone—Hold Mode, Conference—Conference Tone

Feature Manual References

- 1.1.15 Call Hold
- 1.1.33 Conference

Operating Manual References

- 1.3.32 Conference, Unattended
- 1.3.40 Executive Busy Override—Extension
- 1.3.41 Executive Busy Override—Outside (CO) Line
- 3.1.3 Flexible Button Assignment
Create or edit a Conference button.

1.3.32 Conference, Unattended

The proprietary telephone (PT) user who originated a conference with 2 outside parties can leave the conference and allow the other parties to continue the conversation. Certain extensions may be restricted from executing this feature through system programming.



To leave a conference call and establish an unattended conference call

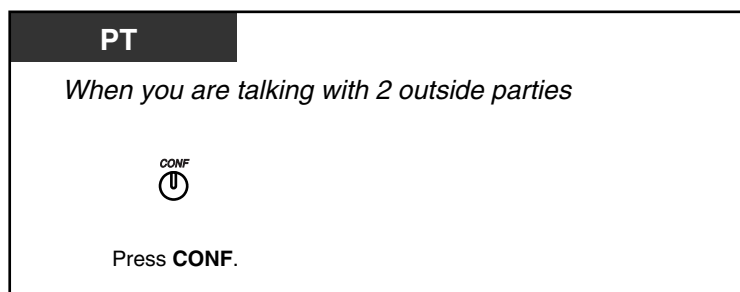

To return while others are talking

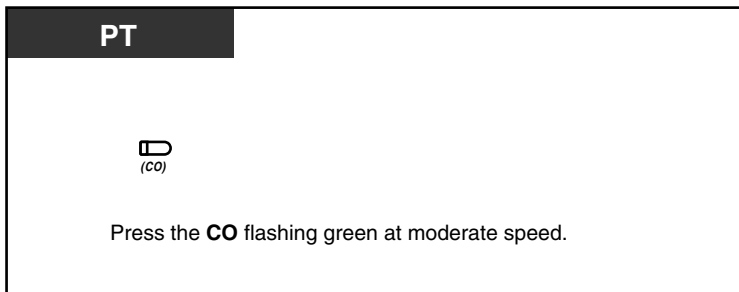

- **CO-to-CO Line Call Duration**

The length of outside-to-outside (CO-to-CO) line calls may be limited through system programming.

Both outside parties will hear a warning tone 15 seconds before a specified time limit. When the timer expires, the call is disconnected.

The originating extension user will hear a ring tone or an alarm tone before the time limit. If the originating extension does not return to the conference within a specified time period, the unattended conference call will be disconnected.



Programming Manual References

[PT Programming]

- [205] CO-to-CO Line Call Duration
- [606] Call Transfer to CO Line

[PC Programming]

- 9.1.7 Timers [1-6]—Call Duration—CO-to-CO Duration Limit
- 9.2.1 Main [2-1]—Transfer to CO

Feature Manual References

- 1.1.34 Conference, Unattended

Operating Manual References

- 1.3.31 Conference
- 3.1.3 Flexible Button Assignment
Create or edit a Conference button.

1.3.33 Data Line Security

You can protect the line against audible notification tones, such as call waiting tones or hold alarm tones during a conversation. Set this feature if your extension has a data communication device such as a computer or fax machine connected, to ensure secure data transmission.

To set/cancel

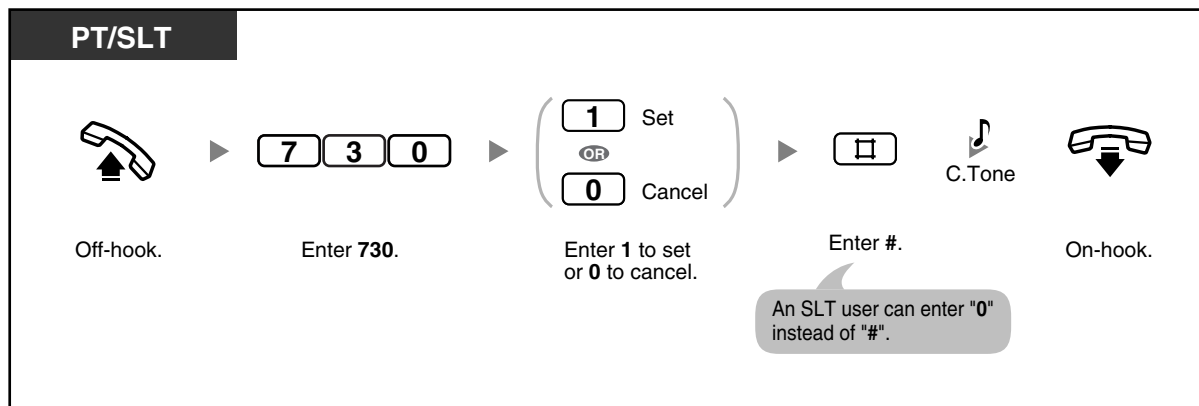

Programming Manual References

[PC Programming]

- 9.2.2 Feature settings [2-2]—Data Line Security

Feature Manual References

- 1.1.15 Call Hold
- 1.1.37 Data Line Security

Operating Manual References

- 1.3.28 Call Waiting
- 1.3.40 Executive Busy Override—Extension
- 1.3.41 Executive Busy Override—Outside (CO) Line

1.3.34 Direct Inward System Access (DISA)

When an outside caller dials a specified telephone number of the PBX, a prerecorded Direct Inward System Access (DISA) outgoing message (OGM) can greet the caller and give information about how to access an extension. The operator does not need to be involved. If there is no recorded message, the caller will hear a short beep instead of the DISA OGM. The operator or manager can record, play, or erase a DISA OGM. Refer to "2.1.5 Outgoing Message (OGM) for DISA"

The caller may also be able to access system features or call an outside party by using the caller's password (DISA security code), depending on the security mode. For more details, refer to "1.1.41 Direct Inward System Access (DISA)" in the Feature Manual.

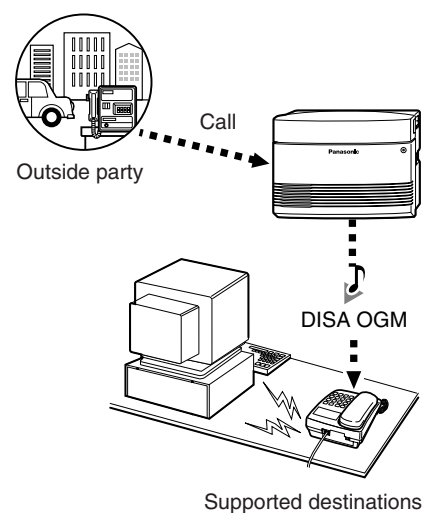

To call an extension

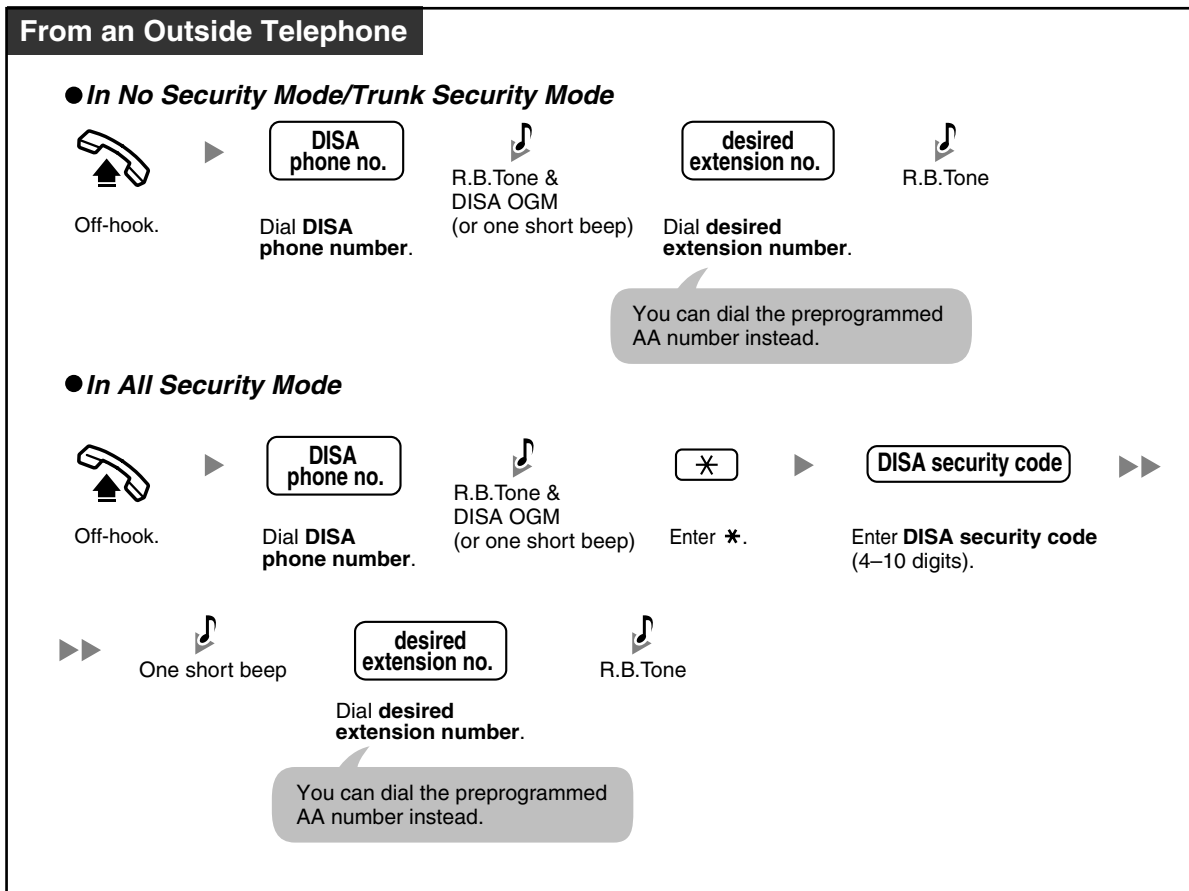

To call an outside party

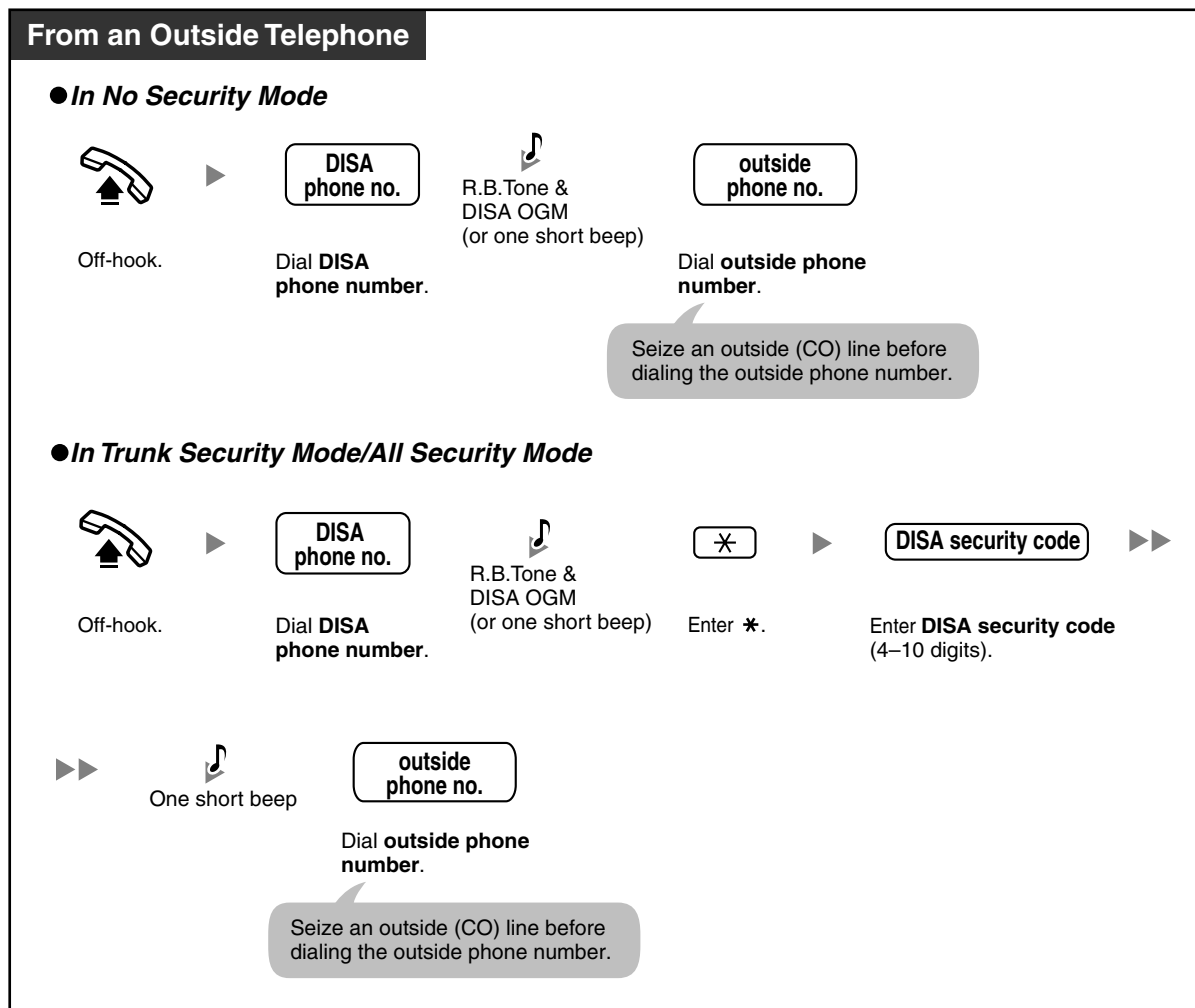

• **WARNING**

There is a risk that fraudulent telephone calls will be made using the Outside-to-Outside (CO-to-CO) Line Call feature of DISA.

The cost of such calls will be billed to the owner/renter of the PBX.

To protect the PBX from this kind of fraudulent use, we strongly recommend:

- a) Enabling DISA security (Trunk Security or All Security).
 - b) Keeping DISA security codes secret.
 - c) Selecting complex, random codes that cannot be easily guessed.
 - d) Changing codes regularly.
- If you dial 4 digits or more when dialing an extension number, the call will be disconnected. When you dial an invalid extension number of 3 digits or less, the call is redirected to the preprogrammed intercept destinations or disconnected, according to system programming.
 - **CO-to-CO Line Call Duration**
The length of outside-to-outside (CO-to-CO) line calls may be limited through system programming. Both the outside caller and the outside destination will hear a warning tone 15 seconds before a specified time limit. When the timer expires, the call is disconnected.

- If the DISA Automated Attendant (AA) service is used, you can access the desired party simply by pressing a preprogrammed single-digit number (DISA AA number) while or after hearing a DISA OGM or after a short beep. AA menus can be up to 3 levels deep.
- If you enter an invalid security code 3 times consecutively, the call will be disconnected automatically. If you enter a DISA security code a second and third time, dialing "*" is not necessary.



Programming Manual References

[PT Programming]

- [009] Extension Number
- [100] Hunting Group Set
- [111] Music on Hold
- [128] Ringback Tone Pattern
- [205] CO-to-CO Line Call Duration
- [408-410] Flexible Ringing—Day/Night/Lunch
- [414-416] CO Line Mode—Day/Night/Lunch
- [420] CPC Signal Detection—Incoming
- [421] CPC Signal Detection—Outgoing
- [438-440] DISA IRNA to BV—Day/Night/Lunch
- [500] DISA Incoming Call Dial Mode
- [501] DISA Built-in AA
- [503] FAX Connection
- [504] DISA Delayed Answer Time
- [505] DISA Wait Time after OGM
- [506] DISA Busy Mode
- [507] DISA Intercept Mode
- [508] DISA Ring Time before Intercept
- [509] DISA Ring Time after Intercept
- [510] DISA No Dial Mode
- [511] DISA Security Mode
- [512] DISA Security Code
- [513] Cyclic Tone Detection
- [514] FAX Tone Detection
- [515] Intercept Time for Internal DISA
- [516] DISA Incoming Assignment
- [517] DISA AA Wait Time
- [518] DISA Tone after Security Code
- [530] DISA Security Code Digits
- [531] DISA Ringback Tone
- [540-549] 3-level AA Assignment
- [600] Extension Group



Programming Manual References

[PC Programming]

- 9.1.2 Main [1-2]—Music on Hold
- 9.1.3 Numbering Plan [1-3]—Ext. no.
- 9.1.7 Timers [1-6]—Call Duration—CO-to-CO Duration Limit
- 9.1.11 Detail [1-10]—Extension—Ringback Tone Pattern
- 9.2.11 Extension Group [2-6]—Group No., Extension Hunting—Extension Hunting
- 9.3.1 Line Mode [3-1]—Mode of incoming CO calls—Day, Night, Lunch
- 9.3.2 Incoming / Outgoing [3-2]—Ringing for incoming CO calls—Day, Night, Lunch
- 9.3.3 Detail [3-3]—CPC Signal Detection—Incoming, CPC Signal Detection—Outgoing
- 9.6 DISA [6]
- 9.8.2 Others [8-2]—DISA IRNA to BV—Day, Night, Lunch

Feature Manual References

- 1.1.41 Direct Inward System Access (DISA)

Operating Manual References

- 2.1.5 Outgoing Message (OGM) for DISA
- 3.2.2 System Programming (Manager Programming)—
[512] DISA Security Code
[530] DISA Security Code Digits

1.3.35 Do Not Disturb (DND)

You can set your telephone to prevent incoming calls from ringing at your telephone. This can be useful in situations where you do not want to be disturbed, for example during a meeting.

To set/cancel

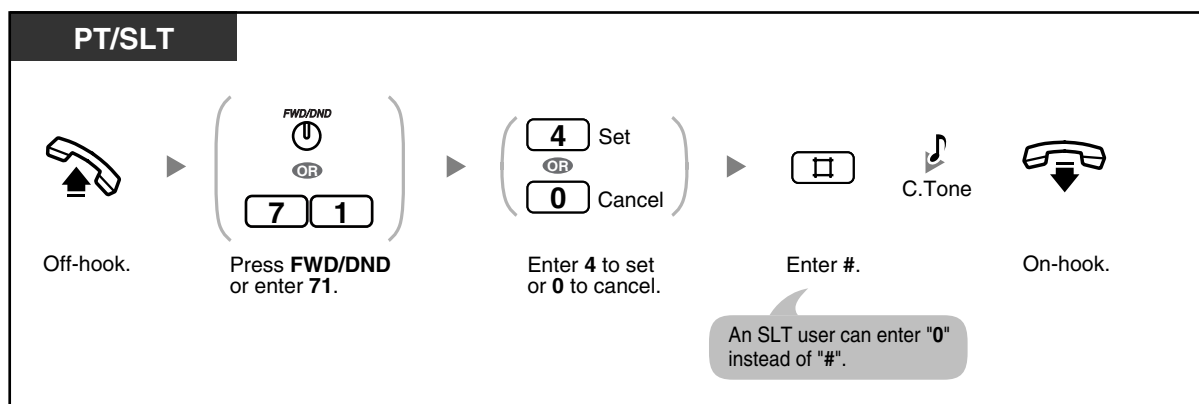



- The FWD/DND (Call Forwarding/Do Not Disturb) button light shows the current status as follows:
Off: Neither feature is set.
Red on: DND mode
Flashing red slowly: FWD mode
- If your extension has set this feature, calling extensions will hear a DND tone.
- If this feature is set, the FWD feature does not function.
- Extensions can override this feature and call extensions in DND mode (DND Override) if they are allowed to do so through system programming.
- Outside (CO) line calls can be received at your extension, but the telephone will not ring. The corresponding CO button will flash when an outside (CO) line call is received, and you can answer the call by pressing this button.
- Even if this feature is set, timed reminder alarms, camp-on recall tones, and hold recall tones (ring tones or alarm tones) will still ring.



Programming Manual References

[PT Programming]

- [414-416] CO Line Mode—Day/Night/Lunch
- [609] DND Override

[PC Programming]

- 9.2.1 Main [2-1]—DND Override
- 9.2.2 Feature settings [2-2]—FWD/DND
- 9.3.1 Line Mode [3-1]—Mode of incoming CO calls—Day, Night, Lunch

Feature Manual References

- 1.1.44 Do Not Disturb (DND)

Operating Manual References

- 1.3.9 Call Forwarding (FWD)—SUMMARY
- 1.3.36 Do Not Disturb (DND) Override
- 3.1.3 Flexible Button Assignment
 Create or edit an FWD/DND (Call Forwarding/Do Not Disturb) button.

1.3.36 Do Not Disturb (DND) Override

You can call users who have set the Do Not Disturb (DND) feature, if your extension is permitted through system programming.

PT/SLT

While hearing the DND tone



Enter 2.



R.B.Tone



Talk.



- If you hear the DND tone, enter "2", and then hear a busy tone, the called extension is busy. You can use the Automatic Callback Busy feature.



Programming Manual References

[PT Programming]

- [609] DND Override

[PC Programming]

- 9.2.1 Main [2-1]—DND Override

Feature Manual References

- 1.1.45 Do Not Disturb (DND) Override

Operating Manual References

- 1.3.5 Automatic Callback Busy (Camp-on)
- 1.3.35 Do Not Disturb (DND)

1.3.37 Door Open

You can unlock a door from your extension, if enabled through system programming.

From an enabled extension

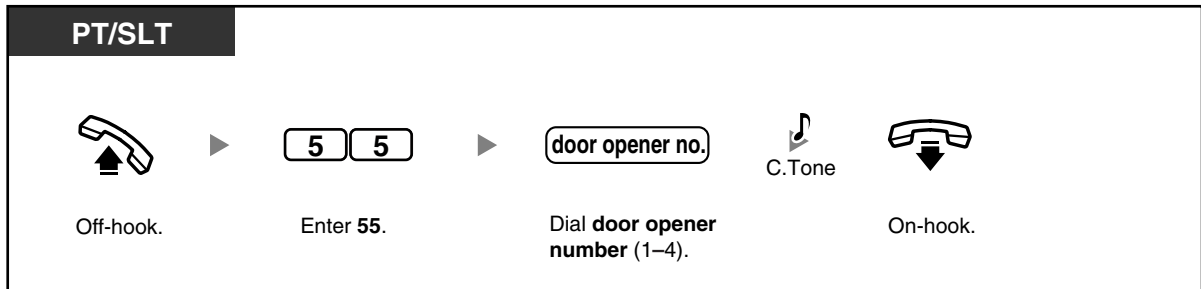

From an extension that is on a call with a doorphone

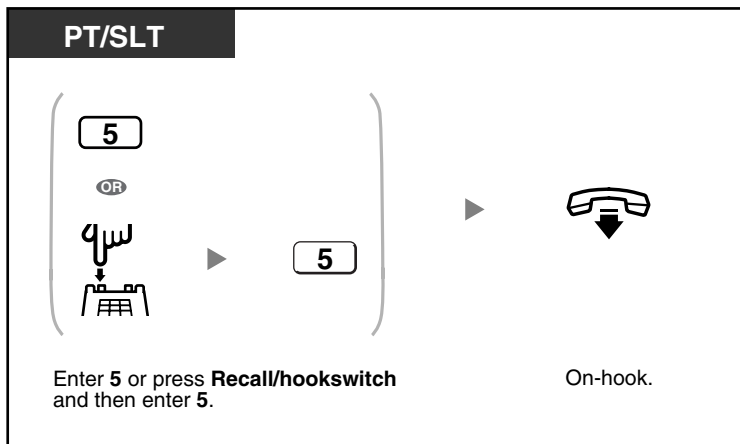



- The door will stay open for a specified time period.
- **To keep the door open longer**, enter "5" again using a Panasonic proprietary telephone (PT).



Programming Manual References

[PT Programming]

- [703-705] Door Opener—Day/Night/Lunch
- [709] Door Open Duration

[PC Programming]

- 9.7.1 Ringing & Door Opener [7-1]—Door Opener 1–4—Day, Night, Lunch
- 9.7.2 Others [7-2]—Door Open Duration—Door 1–4

Feature Manual References

- 1.1.46 Door Open

1.3.38 Doorphone Call

You can talk to a person at the door through the doorphone. The extensions that are permitted to be called when a visitor presses the Call button on a doorphone are determined through system programming.

To call from the doorphone

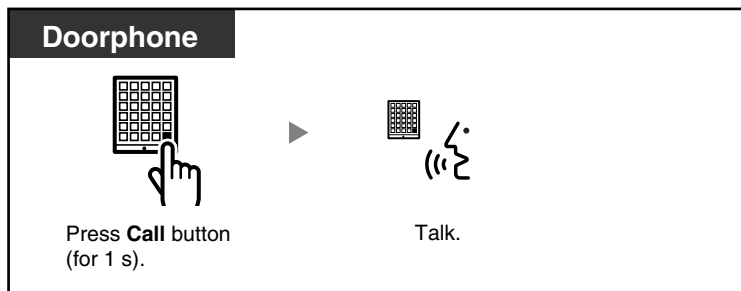

To answer a call from a doorphone

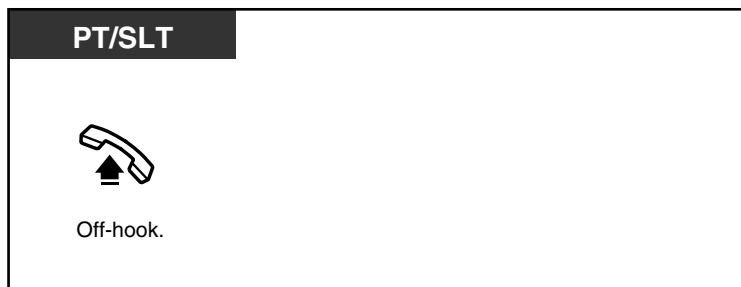

To call a doorphone

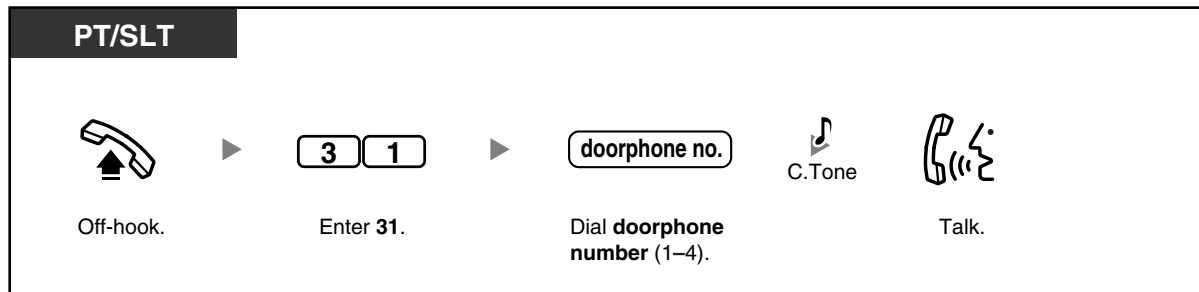

- If no one answers a doorphone call within a specified time period, ringing stops and the call is canceled.
- Doorphones 1 and 2 (or doorphones 3 and 4) cannot be used at the same time. When one is in use, you cannot have a conversation with the other.



Programming Manual References

[PT Programming]

- [700-702] Doorphone Ringing—Day/Night/Lunch
- [706] Doorphone Ring Tone Pattern
- [707] Doorphone Access Tone
- [708] Doorphone Ring Time
- [710] Doorphone Ring/Chime
- [711] Doorphone Chime Assignment
- [712] Doorphone Chime Pattern

[PC Programming]

- 9.7.1 Ringing & Door Opener [7-1]—Doorphone 1-4—Day, Night, Lunch
- 9.7.2 Others [7-2]—Doorphone Ring Tone Pattern—Door 1-4, Doorphone Access Tone—Door 1-4, Doorphone Ring Time—Door 1-4, Doorphone Ring / Chime—Door 1-4, Doorphone Chime Assignment—Door 1-4, Doorphone Chime Pattern—Door 1-4

Feature Manual References

- 1.1.47 Doorbell/Door Chime
- 1.1.48 Doorphone Call

Operating Manual References

- 1.3.80 Room Monitor

1.3.39 Emergency Call

You can dial preprogrammed emergency numbers after seizing an outside (CO) line, regardless of any dialing restrictions on your extension.

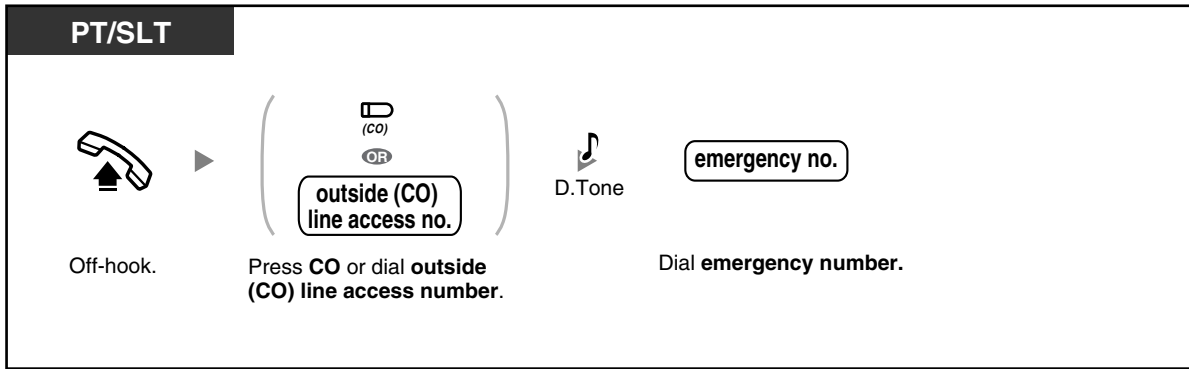

- This feature will function even when:
 - In Account Code—Verify-All/Verify-Toll/Forced Mode
 - Restricted by the current class of service (COS)
 - In Extension Lock



Programming Manual References

[PT Programming]

- [309] Emergency Number
- [403] Host PBX Access Code

[PC Programming]

- 9.3.3 Detail [3-3]—Host PBX Access Codes
- 9.5.4 Emergency Number & Others [5-4]—Emergency Number

Feature Manual References

- 1.1.49 Emergency Call

1.3.40 Executive Busy Override—Extension

You can join an existing intercom call, establishing a 3-party conference call, if your extension is permitted through system programming.

To join an intercom call

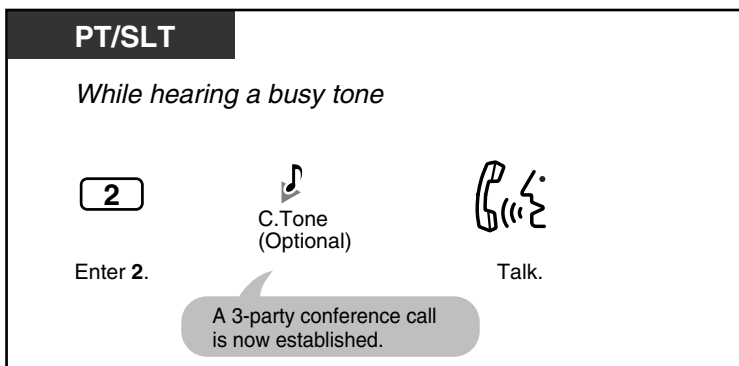

To disconnect one party and talk with another when one of the parties is an outside party

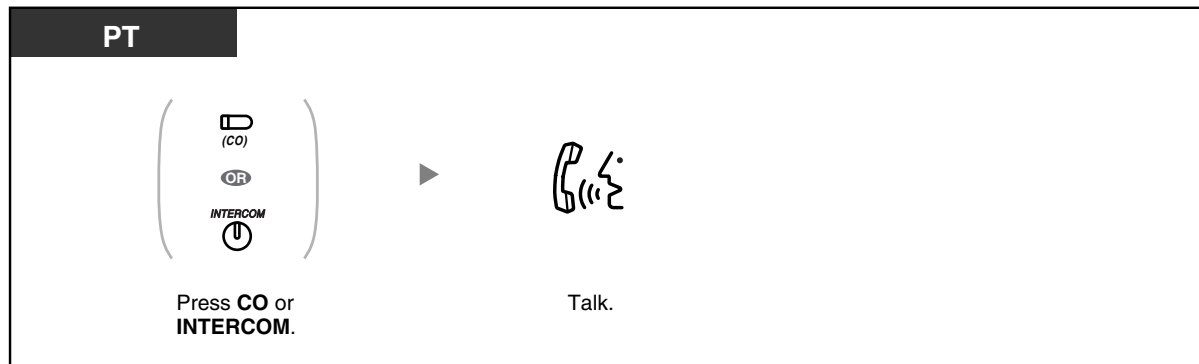

To leave the conference call

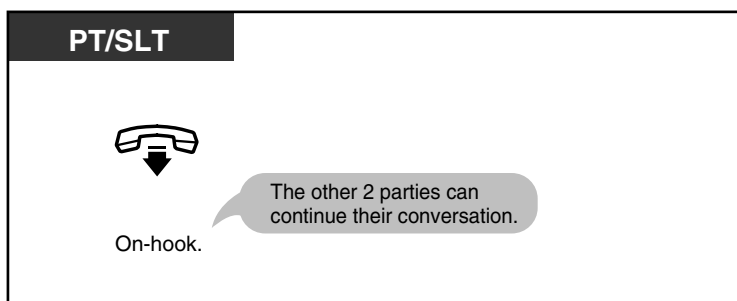

- You can also prevent others from joining your conversations. Refer to "1.3.42 Executive Busy Override Deny".



Programming Manual References

[PT Programming]

- [105] Conference Tone
- [608] Executive Busy Override

[PC Programming]

- 9.1.11 Detail [1-10]—Conference—Conference Tone
- 9.2.1 Main [2-1]—Busy Override

Feature Manual References

- 1.1.50 Executive Busy Override—Extension

Operating Manual References

- 1.3.42 Executive Busy Override Deny

1.3.41 Executive Busy Override—Outside (CO) Line

You can join an existing outside (CO) line call, establishing a 3-party conference call, if your proprietary telephone (PT) is permitted through system programming.



To join an outside (CO) line call

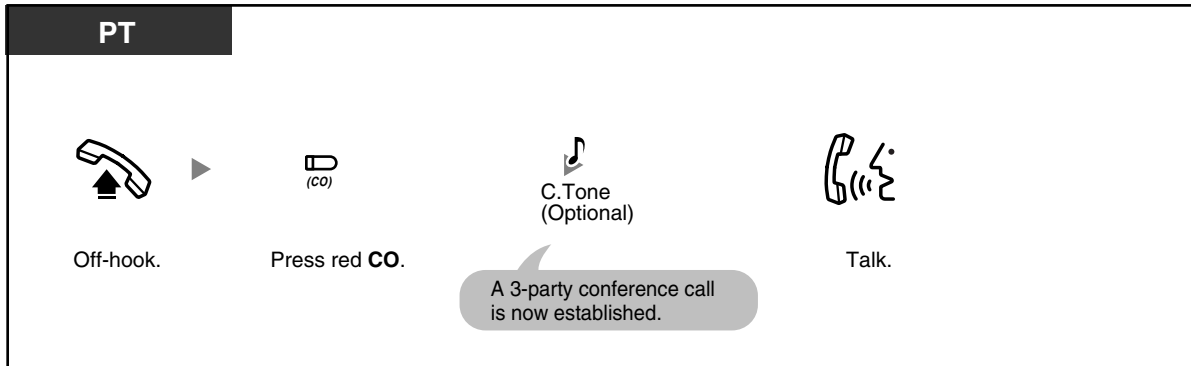

To disconnect one party and talk with another when one of the parties is an outside party

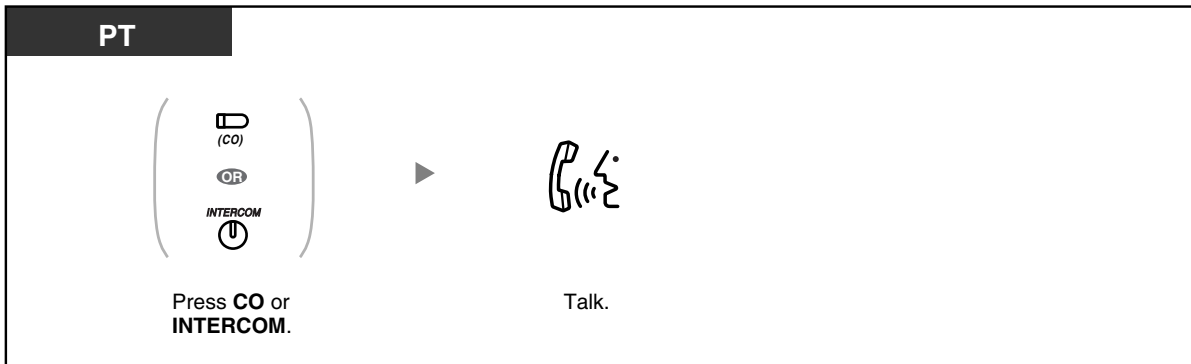

To leave the conference call

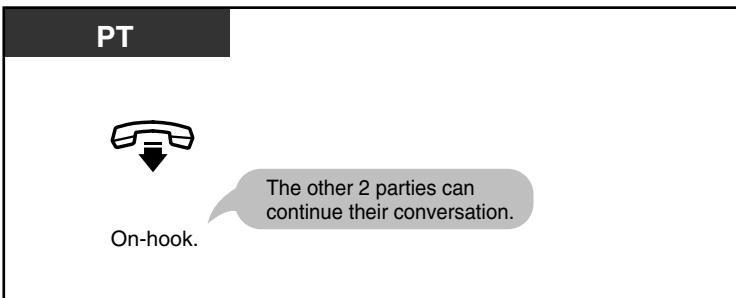

- You can also prevent others from joining your conversations. Refer to "1.3.42 Executive Busy Override Deny".



Programming Manual References

[PT Programming]

- [105] Conference Tone
- [608] Executive Busy Override

[PC Programming]

- 9.1.11 Detail [1-10]—Conference—Conference Tone
- 9.2.1 Main [2-1]—Busy Override

Feature Manual References

- 1.1.51 Executive Busy Override—Outside (CO) Line

Operating Manual References

- 1.3.42 Executive Busy Override Deny

1.3.42 Executive Busy Override Deny

You can prevent other extension users from using the Executive Busy Override feature to join an ongoing call.

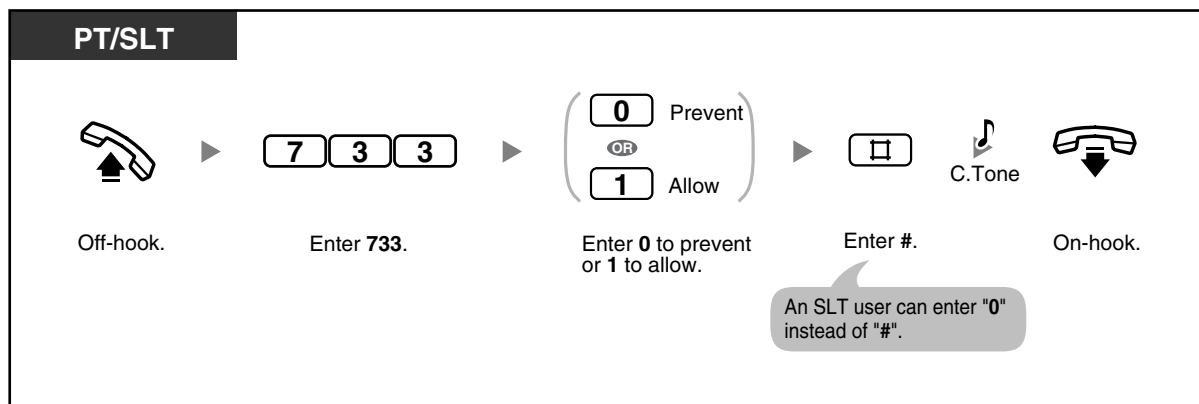

Programming Manual References

[PT Programming]

- [608] Executive Busy Override

[PC Programming]

- 9.2.1 Main [2-1]—Busy Override
- 9.2.2 Feature settings [2-2]—Busy Override Deny

Feature Manual References

- 1.1.50 Executive Busy Override—Extension
- 1.1.51 Executive Busy Override—Outside (CO) Line

Operating Manual References

- 1.3.40 Executive Busy Override—Extension
- 1.3.41 Executive Busy Override—Outside (CO) Line

1.3.43 Extension Feature Clear

You can reset the settings of the following features on your extension to the default settings. This feature is also known as Station Feature Clear or Station Program Clear.

Feature	Value after Extension Feature Clear
Absent Message	Off
Automatic Callback Busy	Off
Background Music (BGM)	Off
Call Forwarding (FWD)	Off
Call Pickup Deny	Allow
Call Waiting	Disable
Data Line Security	Off
Do Not Disturb (DND)	Off
Executive Busy Override Deny	Allow
Hot Line	The stored telephone numbers will be cleared.
Log-in/Log-out	Log-in
Message Waiting	All messages left by other extensions will be cleared.
Paging Deny	Allow
Room Monitor	Off
Timed Reminder	Cleared
Voice Mail Integration	Off

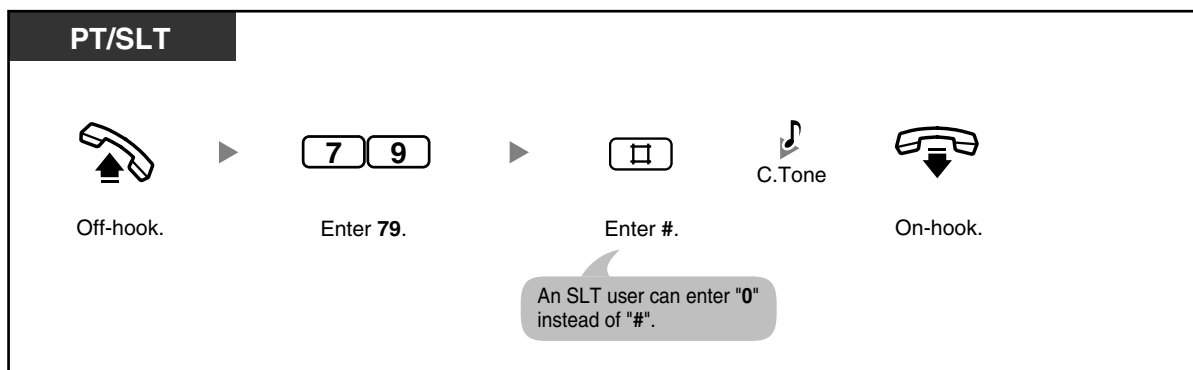

Feature Manual References

- 1.1.52 Extension Feature Clear

1.3.44 Extension Lock

You can lock your extension to prevent other people from using your extension without permission. If your extension is locked, it cannot be used to perform the following operations:

- Making outside (CO) line calls
- Accessing logged information
- Listening to or erasing voice messages recorded by the Built-in Voice Message (BV) feature
- Recording, playing, or erasing BV outgoing messages (OGMs)

However, you may be able to make outside (CO) line calls depending on system programming.

This feature is also known as Electronic Station Lockout.

To lock/unlock

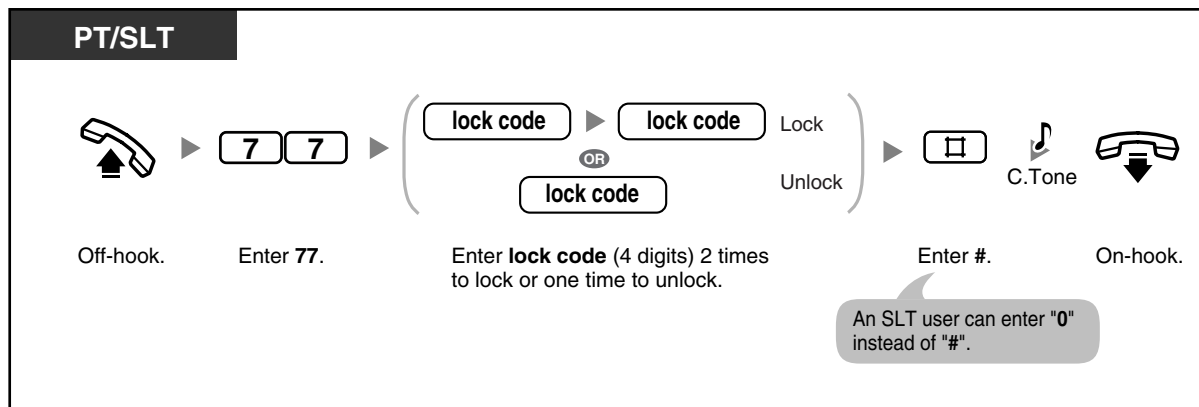

- **If you forget the code or cannot unlock your phone**, ask your operator or manager. He or she can unlock your extension (Remote Extension Lock).
- The lock code must be 4 digits and must not include the "#" or "*" characters.
- The operator or manager can cancel this feature for all extensions (Extension Lock—CANCEL ALL).
- This feature also functions as Call Log Display Lock, Incoming. The Incoming Call Log for the common area can only be locked or unlocked by the operator or manager (Call Log Display Lock, Incoming in the Common Area).



Programming Manual References

[PT Programming]

- [108] Flash/Recall Mode for a Locked Extension
- [312] TRS—Extension Lock Class
- [601-603] TRS-COS—Day/Night/Lunch

[PC Programming]

- 9.1.11 Detail [1-10]—Extension—Flash/Recall Mode for a Locked Extension
- 9.5.1 Class of Service (COS) [5-1]—Day, Night, Lunch
- 9.5.4 Emergency Number & Others [5-4]—Extension Lock Class

Feature Manual References

- 1.1.55 Extension Lock

Operating Manual References

- 1.3.7 Built-in Voice Message (BV)
- 1.3.18 Call Log, Incoming
- 1.3.19 Call Log Display Lock, Incoming in the Personal Area
- 2.1.2 Call Log Display Lock, Incoming in the Common Area
- 2.1.6 Remote Extension Lock
- 2.1.7 System Feature Assignment—Extension Lock—CANCEL ALL

1.3.45 External Feature Access (EFA)

You can access special features such as Call Waiting offered by another PBX or a telephone company. This feature is only available during outside (CO) line calls.

<Example> To hold the current call and then talk to the new party

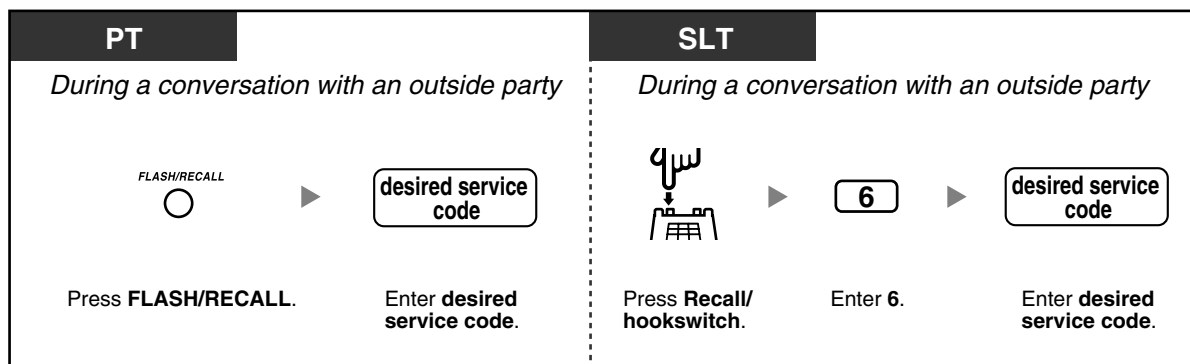

- Consult your dealer for the appropriate service codes.

**Programming Manual References****[PT Programming]**

- [110] Flash/Recall Key Mode
- [418] Flash/Recall Time

[PC Programming]

- 9.1.11 Detail [1-10]—Proprietary Telephone—Flash/Recall Key Mode
- 9.3.3 Detail [3-3]—Flash/Recall Time

Feature Manual References

- 1.1.56 External Feature Access (EFA)

Operating Manual References

- 1.3.46 Flash/Recall

1.3.46 Flash/Recall

You can disconnect the current call and make a call to another party without going on-hook.

PT

While hearing any tone, dialing, or talking

FLASH/RECALL





D.Tone

phone no.

Press **FLASH/RECALL**.

Dial **phone number**.

**Programming Manual References****[PT Programming]**

- [110] Flash/Recall Key Mode
- [418] Flash/Recall Time
- [422] Disconnect Time

[PC Programming]

- 9.1.11 Detail [1-10]—Proprietary Telephone—Flash/Recall Key Mode
- 9.3.3 Detail [3-3]—Flash/Recall Time, Disconnect Time

Feature Manual References

- 1.1.60 Flash/Recall

Operating Manual References

- 1.3.45 External Feature Access (EFA)

1.3.47 Hands-free Answerback

You can set your proprietary telephone (PT) to answer incoming intercom calls without going off-hook. When an intercom call arrives, you will hear the caller talking without the phone ringing.



To set/cancel

PT

While on-hook

AUTO ANS

MUTE

Press **AUTO ANS/MUTE**.



- The AUTO ANS/MUTE button light shows the current status as follows:
Off: Not set
Red on: Set
- This feature is not available for incoming outside (CO) line calls and doorphone calls.



Feature Manual References

- 1.1.62 Hands-free Answerback

1.3.48 Hands-free Operation

You can dial and talk to another party in hands-free mode using the SP-PHONE button.



PT

While on-hook

SP-PHONE

Press **SP-PHONE**.

To switch from the handset to hands-free mode

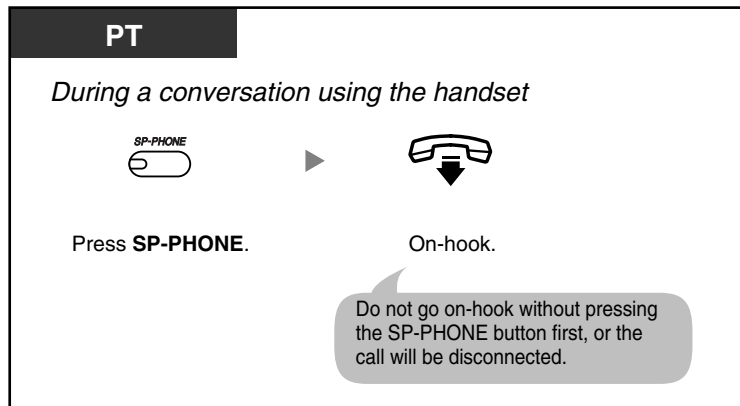

To switch from hands-free mode to the handset

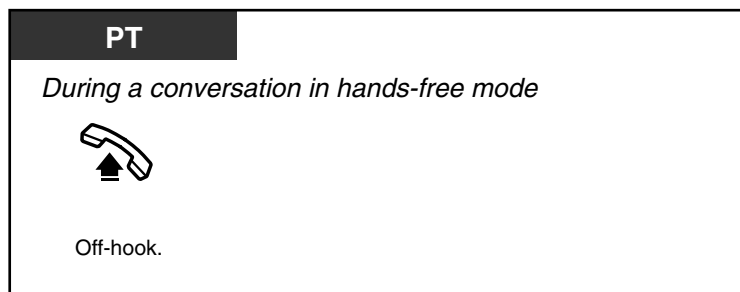

- **Helpful hints for hands-free operation:**

- **If it is difficult to hear the other party's voice:**
Increase the volume using the Navigator Key or Volume Key.
- **If the other party has difficulty hearing you:**
Decrease the volume.
- **If the other party reports that your voice echoes:**
Use the telephone in a room that has curtains, carpeting or both.
- **If parts of the conversation cannot be heard:**
If you and the other party speak at the same time, parts of your conversation may be lost. To avoid this, try to speak alternately.



Feature Manual References

- 1.1.63 Hands-free Operation

1.3.49 Headset Operation

Connecting an optional headset allows for hands-free conversations. This feature is also known as Handset/Headset Selection.



To talk using the headset

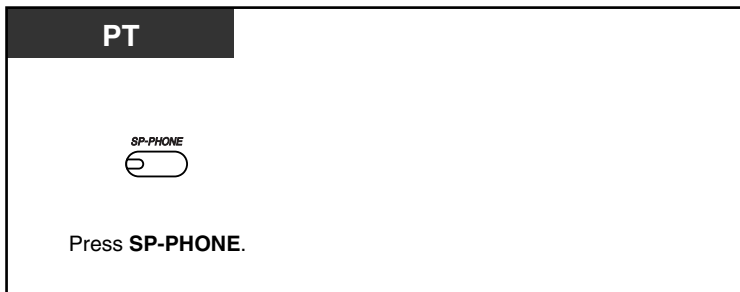

Feature Manual References

- 1.1.64 Headset Operation

1.3.50 Hot Line

A single line telephone (SLT) user can make a call simply by going off-hook, if the telephone number has been stored beforehand.

This feature is also known as Pickup Dialing.

To store a phone number

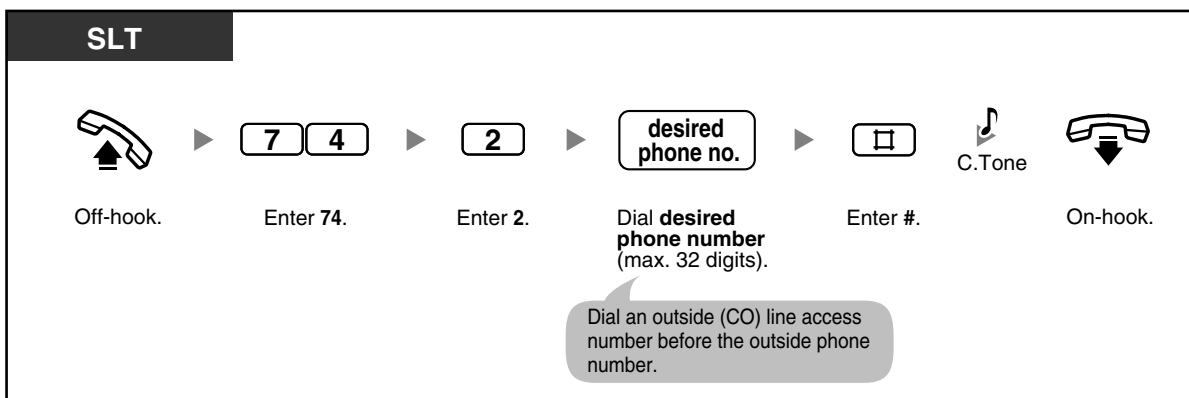

To set/cancel

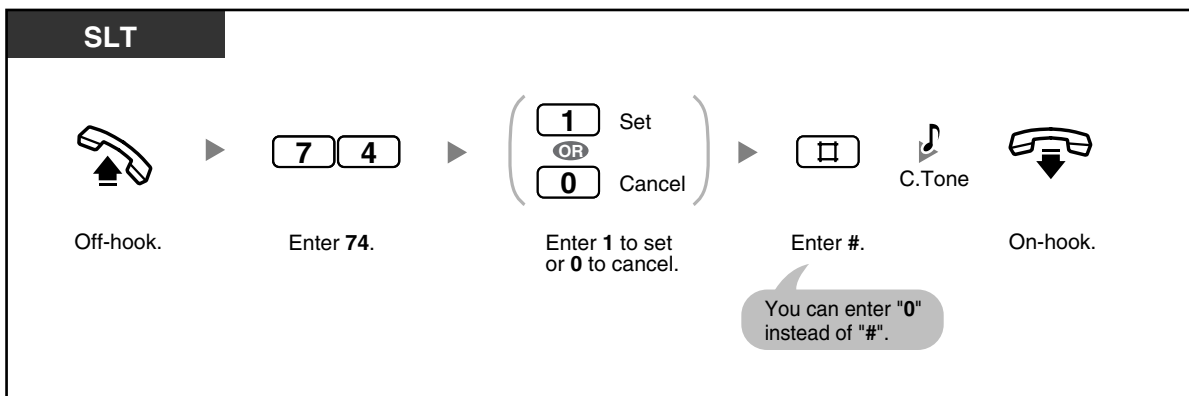

To dial

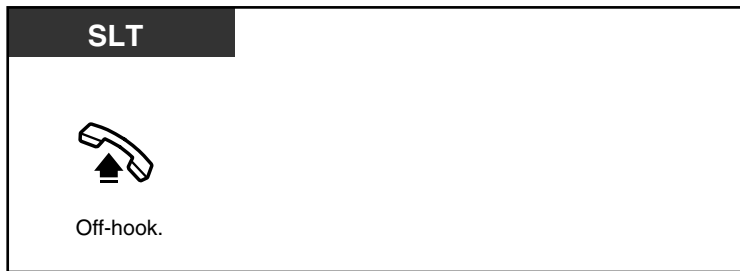

- **To call another party**, dial the desired party's phone number before the preprogrammed number is dialed.
- Up to 32 digits including "*" can be stored. However, depending on your mode of account code entry, "*" may not be regarded as a pause.
- Rotary SLT users cannot program this feature.



Programming Manual References

[PT Programming]

- [203] Hot Line Waiting Time

[PC Programming]

- 9.1.7 Timers [1-6]—Start Time—Hot Line
- 9.2.2 Feature settings [2-2]—Hot Line for SLT

Feature Manual References

- 1.1.66 Hot Line

1.3.51 Intercom Call

You can call another extension.

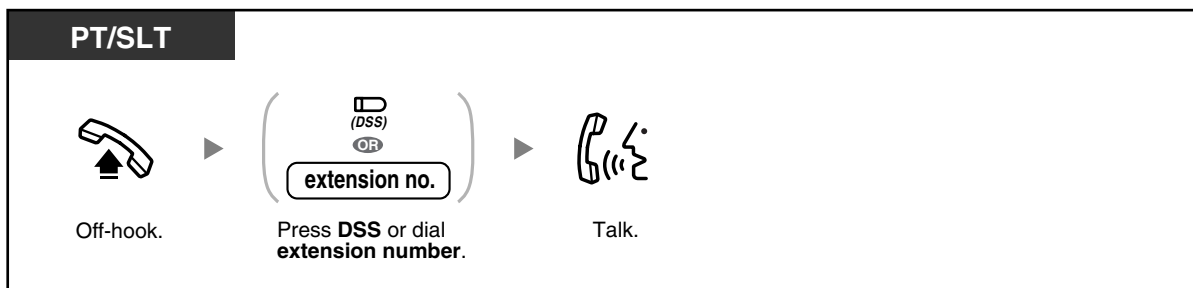

- The Direct Station Selection (DSS) button light shows the current status as follows:
Off: The extension is idle.
Red on: The extension is on a call.



- **For quick operation**
If you are the operator or dial certain extension numbers frequently, DSS buttons are useful.
- **Hands-free Operation**
You can make an intercom call and have a conversation in hands-free mode using the SP-PHONE/INTERCOM button. Refer to "1.3.48 Hands-free Operation".



Programming Manual References

[PT Programming]

- [009] Extension Number
- [115] Extension Ring Tone Pattern
- [128] Ringback Tone Pattern
- [604] Extension Name

[PC Programming]

- 9.1.3 Numbering Plan [1-3]
- 9.1.11 Detail [1-10]—Extension—Ring Tone Pattern, Extension—Ringback Tone Pattern

Feature Manual References

- 1.1.69 Intercom Call

Operating Manual References

- 1.3.48 Hands-free Operation
- 3.1.3 Flexible Button Assignment
Create or edit a Direct Station Selection (DSS) button.

1.3.52 Line Access, Outside (CO) Line—SUMMARY

There are 3 methods of seizing an outside (CO) line. Use whichever method you prefer, unless requested by your manager to use a specific method.

Choose one of the following methods:

Line Access, Automatic

Line Access, Outside (CO) Line Group

Line Access, S-CO Line



- **Line Access, Direct Outside (CO) Line**
You can press the S-CO or G-CO button without going off-hook first.
- The Single-CO (S-CO) and Group-CO (G-CO) button lights show the current status as follows:
 - Off:** The line is idle.
 - Green on:** You are using the line.
 - Red on:** Another extension is using the line (S-CO), or other extensions are using all outside (CO) lines in the outside (CO) line group (G-CO).
- **Emergency Call**
You can dial preprogrammed emergency numbers after seizing an outside (CO) line without any restrictions.
- You may be restricted from making calls to certain outside parties. If you have questions about your calling restrictions, consult your manager or dealer.



- **To make a call to another party without going on-hook**, press the FLASH/RECALL button. Pressing the button will re-access the outside (CO) line and provide an external dial tone. You can dial the new phone number without going on/off-hook.
- **Hands-free Operation**
You can make an outside (CO) line call and have a conversation in hands-free mode using the SP-PHONE button. Refer to "1.3.48 Hands-free Operation".



Programming Manual References

[PT Programming]

- [206] Dialing Start Time
- [400] CO Line Connection
- [404] CO Line Group Number
- [405-407] Flexible Outward Dialing—Day/Night/Lunch
- [419] Automatic Designated Line Access

[PC Programming]

- 9.1.7 Timers [1-6]—CO Dialing—Dialing Start Time
- 9.3.2 Incoming / Outgoing [3-2]—Outgoing Call—Day, Night, Lunch
- 9.3.3 Detail [3-3]—Connection, CO Line Group, Automatic Line Access

Feature Manual References

- 1.1.71 Line Access, Outside (CO) Line—SUMMARY

Operating Manual References

- 1.3.2 Account Code Entry
- 1.3.39 Emergency Call
- 1.3.44 Extension Lock
- 1.3.46 Flash/Recall
- 1.3.48 Hands-free Operation
- 1.3.85 Toll Restriction (TRS)
- 2.1.6 Remote Extension Lock
- 3.1.2 Personal Feature Assignment—**Line Preference—Outgoing**
Select the seized line when going off-hook.
- 3.1.3 Flexible Button Assignment
Create or edit a Single-CO (S-CO) button, Group-CO (G-CO) button, or Other-CO (O-CO) button.

1.3.53 Line Access, Automatic

You can select an idle outside (CO) line automatically. You can also select an idle outside (CO) line from among the outside (CO) lines that are not assigned to Single-CO (S-CO) or Group-CO (G-CO) buttons (Line Access Using the Other-CO (O-CO) Button).

To select an idle outside (CO) line automatically

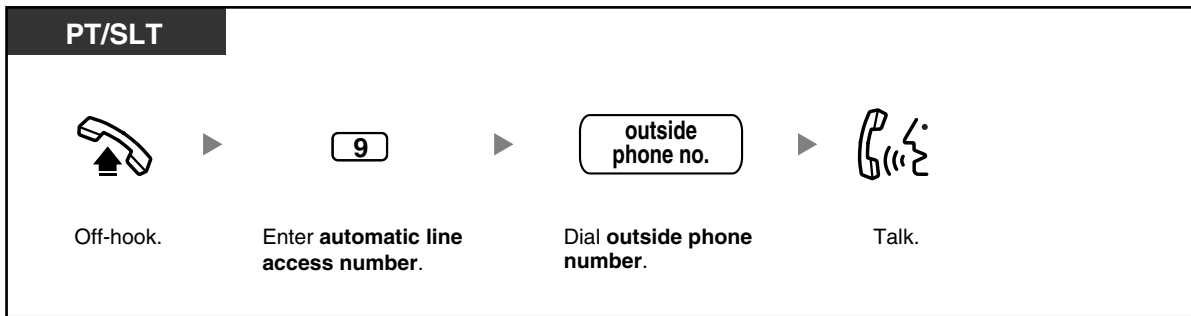

To select an idle unassigned outside (CO) line

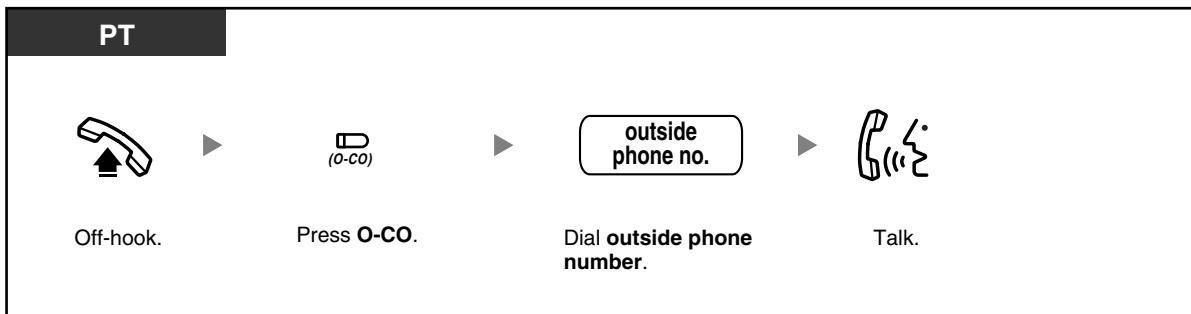

Programming Manual References

[PT Programming]

- [206] Dialing Start Time
- [400] CO Line Connection
- [405-407] Flexible Outward Dialing—Day/Night/Lunch
- [419] Automatic Designated Line Access

[PC Programming]

- 9.1.7 Timers [1-6]—CO Dialing—Dialing Start Time
- 9.3.2 Incoming / Outgoing [3-2]—Outgoing Call—Day, Night, Lunch
- 9.3.3 Detail [3-3]—Connection, Automatic Line Access

Feature Manual References

- 1.1.72 Line Access, Automatic

1.3.54 Line Access, Outside (CO) Line Group

You can select an idle outside (CO) line in the specified outside (CO) line group (1–8) automatically.

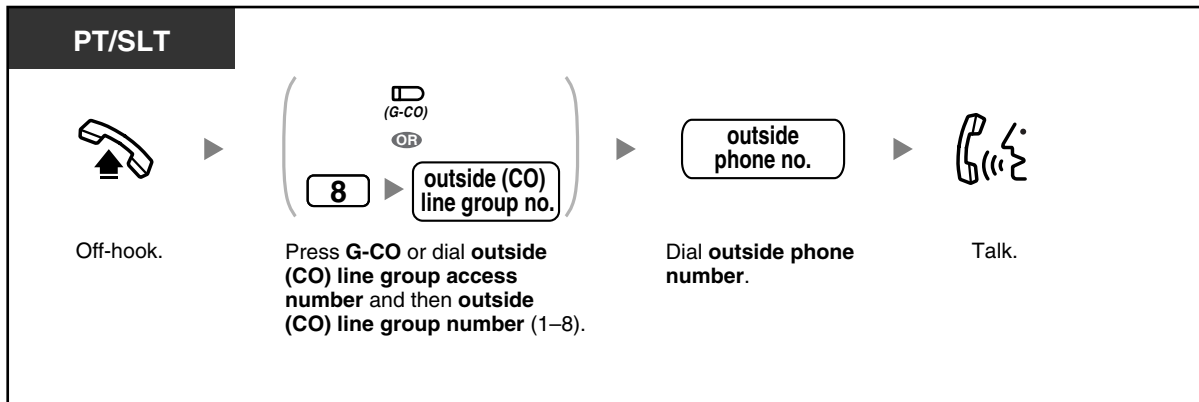

- You can press the G-CO button without going off-hook first.



Programming Manual References

[PT Programming]

- [206] Dialing Start Time
- [400] CO Line Connection
- [404] CO Line Group Number
- [405-407] Flexible Outward Dialing—Day/Night/Lunch

[PC Programming]

- 9.1.7 Timers [1-6]—CO Dialing—Dialing Start Time
- 9.3.2 Incoming / Outgoing [3-2]—Outgoing Call—Day, Night, Lunch
- 9.3.3 Detail [3-3]—Connection, CO Line Group

Feature Manual References

- 1.1.73 Line Access, Outside (CO) Line Group

1.3.55 Line Access, S-CO Line

You can select a specified outside (CO) line.

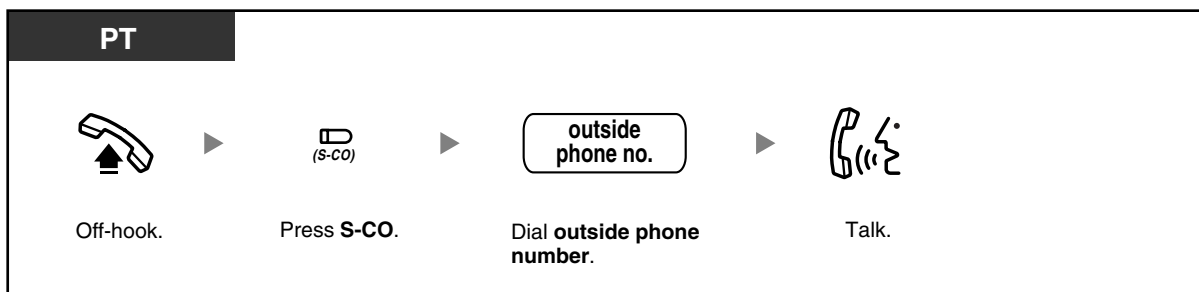

- You can press the S-CO button without going off-hook first.



Programming Manual References

[PT Programming]

- [206] Dialing Start Time
- [400] CO Line Connection
- [405-407] Flexible Outward Dialing—Day/Night/Lunch

[PC Programming]

- 9.1.7 Timers [1-6]—CO Dialing—Dialing Start Time
- 9.3.2 Incoming / Outgoing [3-2]—Outgoing Call—Day, Night, Lunch
- 9.3.3 Detail [3-3]—Connection

Feature Manual References

- 1.1.74 Line Access, S-CO Line

1.3.56 Live Call Screening (LCS) (Voice Mail APT Integration only)

While a caller is leaving a message in your mailbox, you can monitor the call, and choose whether to answer or not. There are 2 methods available. (Default: Hands-free mode)

Hands-free mode:

You can monitor the message automatically, live through the telephone speaker.

Private mode:

You will hear the following alert tone while the caller is leaving a message.

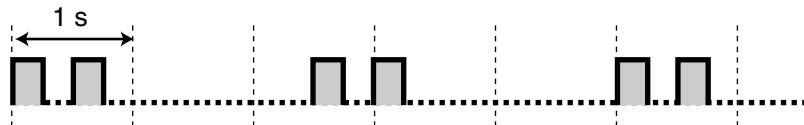

This feature is available when the PBX is connected to a Panasonic Voice Processing System (VPS) that supports APT integration.



No SLT

Before operating

- Create a Live Call Screening (LCS) button.
- Select the mode, either Hands-free or Private.
- Set the LCS password.
- Set the LCS feature.

To set/cancel the LCS password

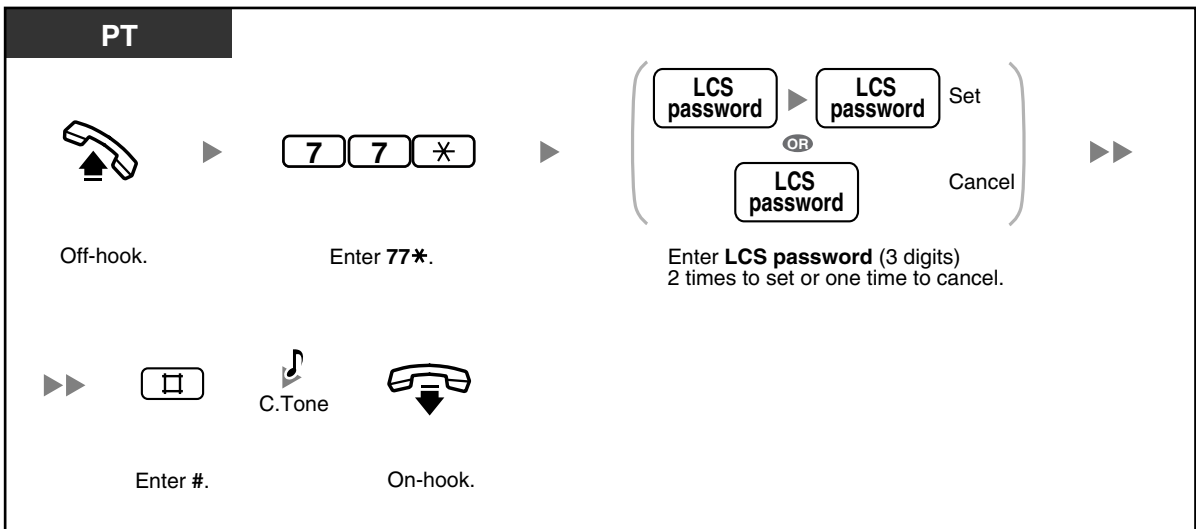

To set LCS

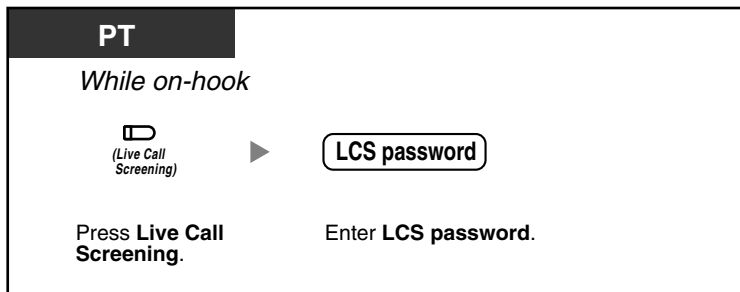

To cancel LCS

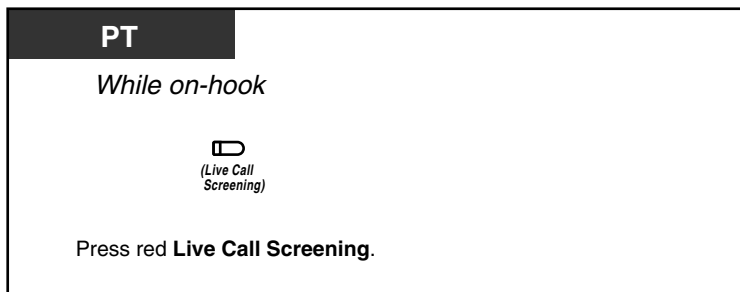

Operation Flowchart

The operations in the shaded areas can be performed in hands-free mode.

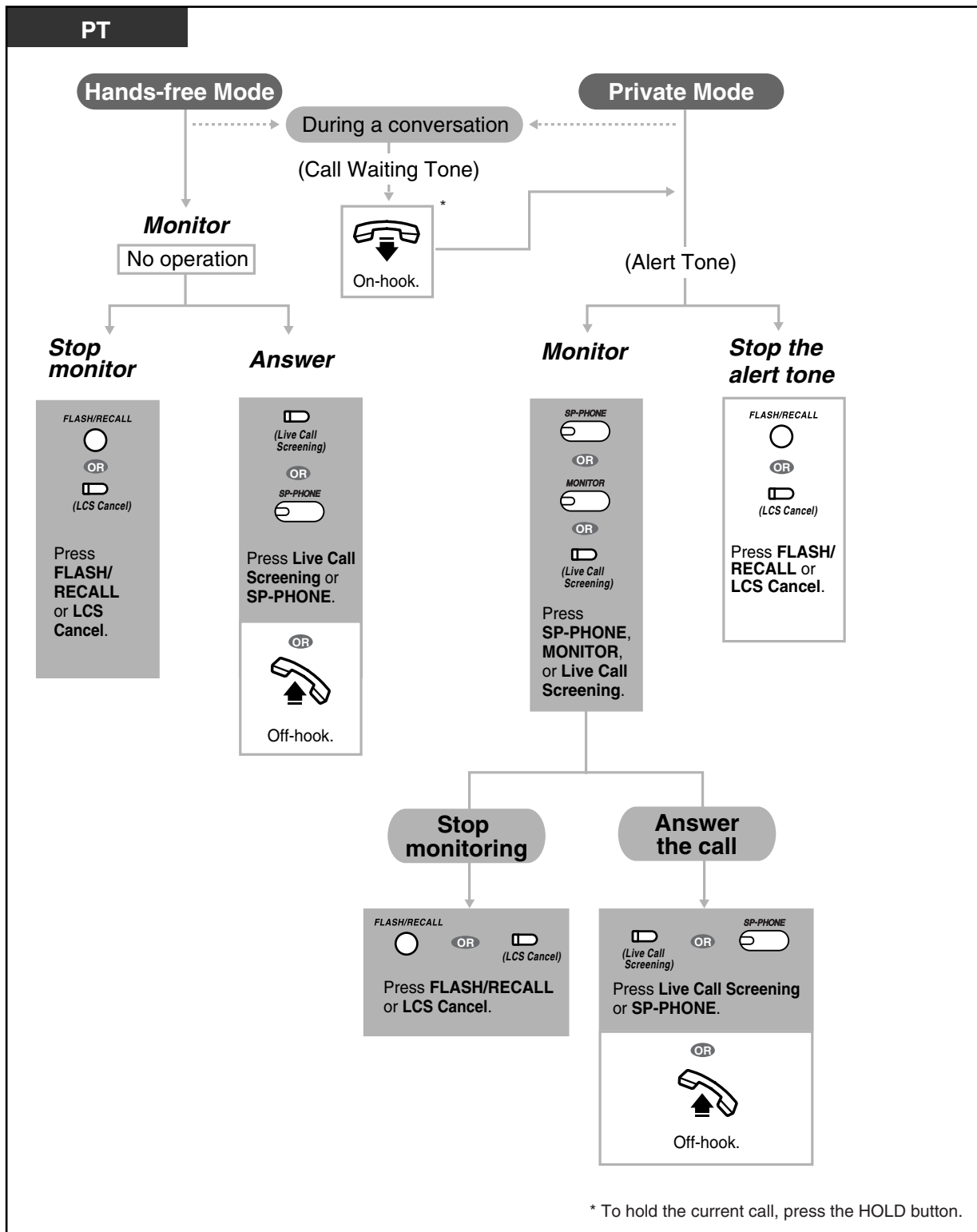



- The Live Call Screening (LCS) button light shows the feature status as follows:

Off: LCS is off.

Flashing green rapidly: An alert tone is ringing (Private mode only).^{*1}

Flashing green slowly: Monitoring.^{*2}

Red on: LCS is on.

^{*1} The Direct Station Selection (DSS) button light flashes red at moderate speed while an alert tone is ringing.

^{*2} The DSS button light flashes red slowly while monitoring.

- The operator or manager can clear the LCS password at any extension.



Programming Manual References

[PT Programming]

- [620] LCS Recording Mode Set

[PC Programming]

- 9.2.1 Main [2-1]—LCS Recording Mode
- 9.2.2 Feature settings [2-2]—LCS Password

Feature Manual References

- 1.1.77 Live Call Screening (LCS) (Voice Mail APT Integration only)

Operating Manual References

- 2.1.7 System Feature Assignment—Live Call Screening (LCS) Password Control
- 3.1.2 Personal Feature Assignment—**Live Call Screening [LCS] Mode Set**
Select the mode, either monitoring the message through the speaker automatically or receiving an alert tone, while the caller leaves a message.
- 3.1.3 Flexible Button Assignment
Create or edit a Live Call Screening (LCS) button or LCS Cancel button.

1.3.57 Local Carrier-based Voice Mail Service

It is possible to use voice mail service provided by your telephone company. After subscription, the telephone company's voice mail system can answer calls automatically when you are busy or calls are not answered, and callers can leave their messages in your mailbox of the voice mail system located at the telephone company. You will receive an indication to notify you that a message is waiting. The Message/Ringer Lamp will light red and a Single-CO (S-CO) button will flash red at moderate speed after the mailbox has received messages, on a proprietary telephone (PT).



No SLT

To listen to messages



- If your telephone company sends a special signal (Stutter dial tone) when you seize the outside (CO) line, this is an indication that a new message was recorded. Approximately 5 seconds after the user hangs up one of the preprogrammed outside (CO) lines, or 3 minutes 46 seconds after the phone stops ringing, the PBX automatically seizes the line and checks if a message has been recorded. If a new message was recorded in the mailbox of the telephone company, the Message/Ringer Lamp lights red and the corresponding S-CO button flashes red moderately.
- If your voice mail service uses a stutter dial tone and the recorded message is over 3 minutes long, in some cases the Message/Ringer Lamp may not light and the corresponding S-CO button may not flash.
- A contract with your telephone company may be required for local carrier-based voice mail service. For more details, consult your telephone company.



Programming Manual References

[PT Programming]

- [435] Local Carrier-based Voice Mail Signaling
- [436] Local Carrier-based Voice Mail Access Dial
- [437] Extension Access to Local Carrier-based Voice Mail

[PC Programming]

- 9.3.4 Local Carrier-based VM [3-4]

Feature Manual References

- 1.1.78 Local Carrier-based Voice Mail Service

Operating Manual References

- 3.1.3 Flexible Button Assignment
Create or edit a Single-CO (S-CO) button or Message button.

1.3.58 Lockout

If one party in a conversation goes on-hook, the call between both parties will be disconnected. A reorder tone is sent to the off-hook party before the call is disconnected. No operation is necessary. For more details, refer to "1.1.79 Lockout" in the Feature Manual.



Feature Manual References

- 1.1.79 Lockout

1.3.59 Log-in/Log-out

You can change your status in an extension group (idle extension hunting group/DISA ring group). When you log out, incoming calls to the group will not ring at your extension. When you log back in, calls will again ring at your extension. (Default: Log-in)

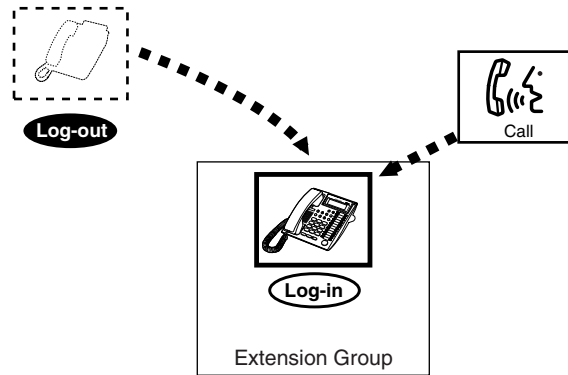

To set Log-in/Log-out

PT/SLT

Off-hook.

▶

7 3 6

▶

Enter **736**.

▶

0 Log-in
OR
1 Log-out

▶

Enter **0** to log-in or **1** to log-out.

▶

#

▶

Enter **#**.

▶

C.Tone

▶

On-hook.

An SLT user can enter "0" instead of "#".

PT

Off-hook.

▶

(Log-in/Log-out)

▶

Press **Log-in/Log-out**.

▶

C.Tone

▶

On-hook.



- The Log-in/Log-out button light shows the current status as follows:
Off: Log-in mode
Red on: Log-out mode
- The last member of a group cannot log out.



Programming Manual References

[PT Programming]

- [100] Hunting Group Set
- [600] Extension Group

[PC Programming]

- 9.2.2 Feature settings [2-2]—Log-in / Log-out
- 9.2.11 Extension Group [2-6]—Group No., Extension Hunting—Extension Hunting

Feature Manual References

- 1.1.80 Log-in/Log-out

Operating Manual References

- 3.1.3 Flexible Button Assignment
Create or edit a Log-in/Log-out button.

1.3.60 Message Waiting

- Leaving a Message Waiting Indication
- Calling Back a Caller Who Left an Indication

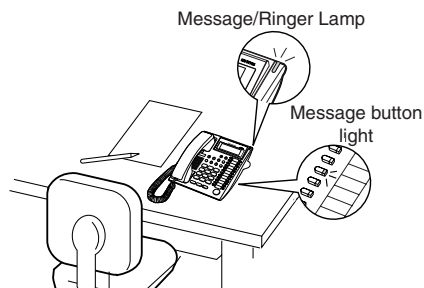

When the called extension is busy or does not answer your call, you can leave a notification so that the called party may call you back.

When you receive a message waiting indication, the MESSAGE button light or Message/Ringer Lamp will light. You can call back the caller simply by pressing the lit MESSAGE button.



◆◆ Leaving a Message Waiting Indication

To leave a message waiting indication

PT		
<i>When the called extension is busy or does not answer</i>		
 MESSAGE	 C.Tone	 On-hook.
Press MESSAGE .		

To leave/cancel a message waiting indication

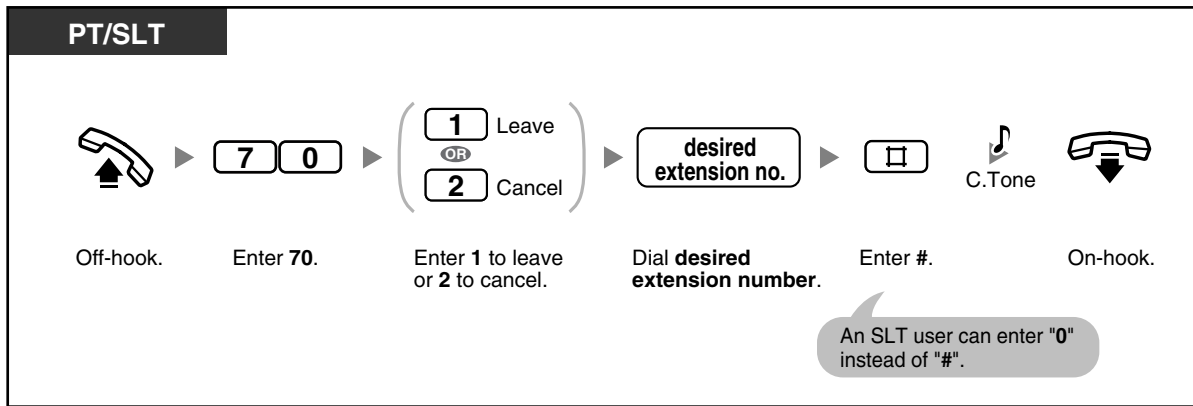

To cancel a message waiting indication using the MESSAGE button

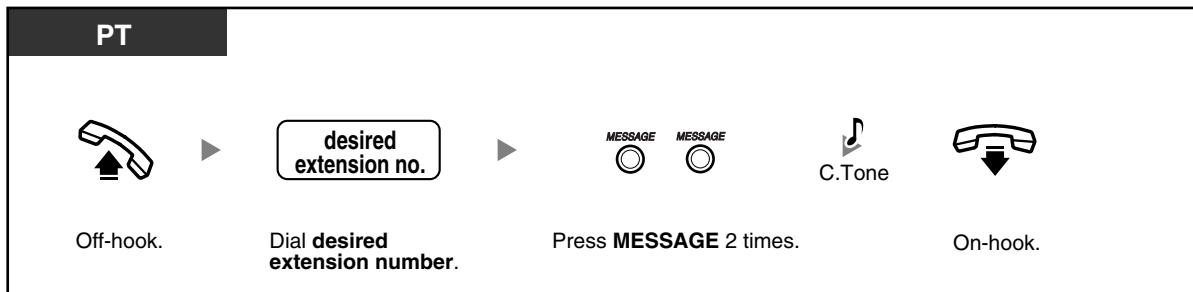

◆◆ **Calling Back a Caller Who Left an Indication**

To check a received message and call back

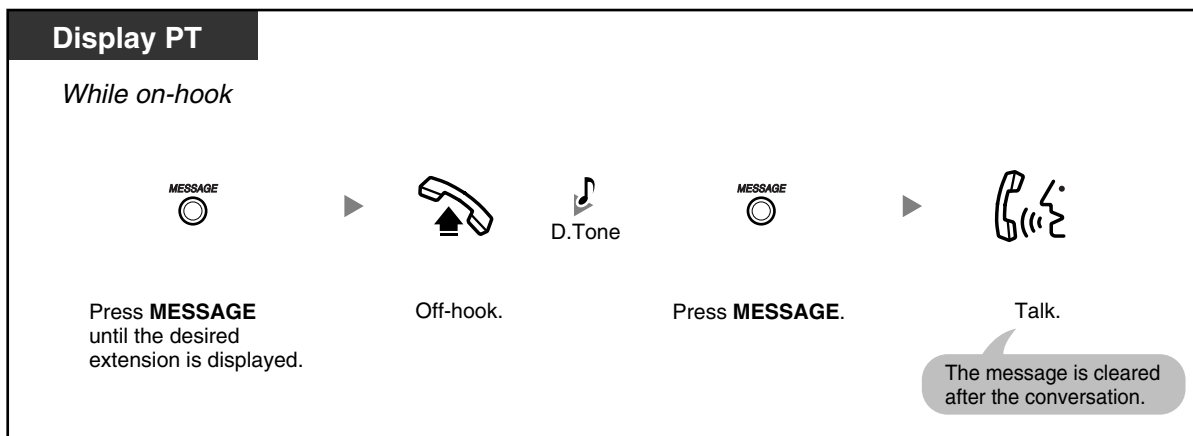

To cancel all message waiting indications left at your extension

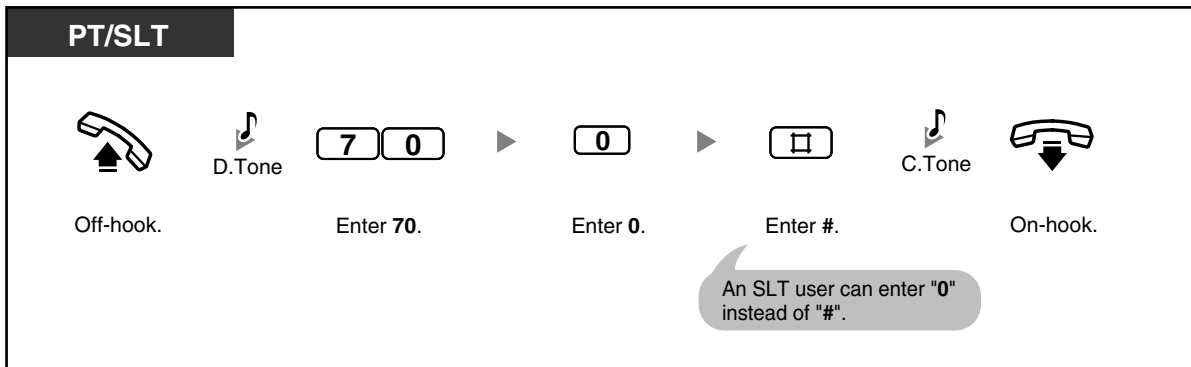

- The MESSAGE button light or Message/Ringer Lamp shows the current status as follows:
Off: No messages
Red on: New messages.
- The display shows messages in the order received, starting with the selected message.
<Example>
 5→6→7→8→1→2→3→4
- The MESSAGE button is used to perform operations and display notifications from both the Message Waiting and Built-in Voice Message (BV) features. If a message has also been left in a voice message area, "Voice Message" will be shown on a display PT when the MESSAGE button is pressed. Refer to "1.3.7 Built-in Voice Message (BV)".
- Each extension can have a maximum of 8 messages waiting when using the Message Waiting feature, or a maximum of 125 voice messages waiting when using the BV feature.
- If you go off-hook with a single line telephone (SLT) that has messages waiting, a special dial tone (dial tone 3) will be heard. You can call a caller back or listen to the message by entering the Message Waiting Answer feature number, "784# (7840)".



Programming Manual References

[PT Programming]

- [619] SLT Message Waiting

[PC Programming]

- 9.2.1 Main [2-1]—SLT MW

Feature Manual References

- 1.1.82 Message Waiting

Operating Manual References

- 1.3.7 Built-in Voice Message (BV)
- 1.3.61 Message Waiting for Another Extension
- 3.1.3 Flexible Button Assignment
 Create or edit a Message button.

1.3.61 Message Waiting for Another Extension

You can check messages left at another extension and call back the caller simply by pressing the lit Message for Another Extension button, if your proprietary telephone (PT) is permitted through system programming. You can also clear all messages left at another extension.



To check a received message and call back

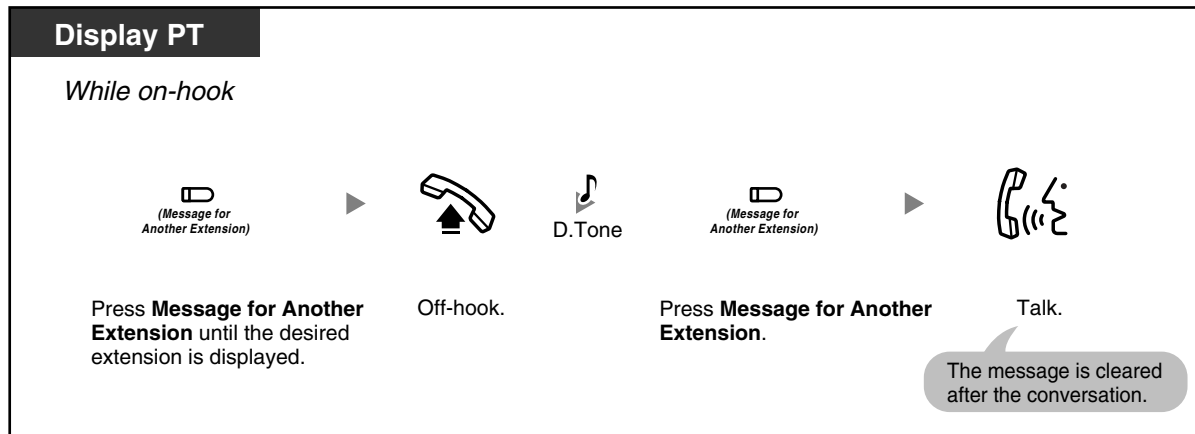

To cancel all message waiting indications left at another extension

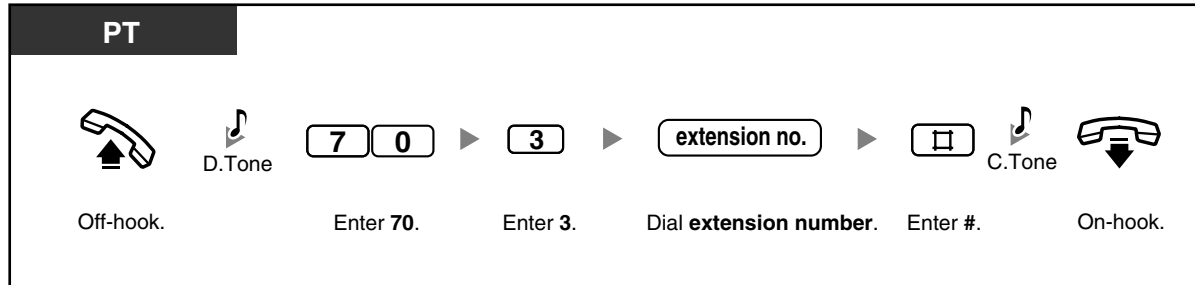

- On your PT, you can establish one or more Message for Another Extension buttons. These buttons can display message waiting indications left at other telephones.
- **To cancel all message waiting indications left at another extension**, it is necessary to first assign the corresponding Message for Another Extension buttons on your phone.
- The Message/Message for Another Extension button light or Message/Ringer Lamp shows the current status as follows:
Off: No messages
Red on: New messages.
- The display shows messages in the order received, starting with the selected message.
<Example>
5→6→7→8→1→2→3→4



Programming Manual References

[PT Programming]

- [618] Message Waiting for Another Extension

[PC Programming]

- 9.2.1 Main [2-1]—MW for Another Extension

Feature Manual References

- 1.1.83 Message Waiting for Another Extension

Operating Manual References

- 1.3.60 Message Waiting
- 3.1.3 Flexible Button Assignment
Create or edit a Message for Another Extension button.

1.3.62 Message Waiting for Another Extension Lock

You can lock message waiting indications so that other extensions cannot confirm, call back, or clear message waiting indications left at your extension.

To lock/unlock message waiting indications

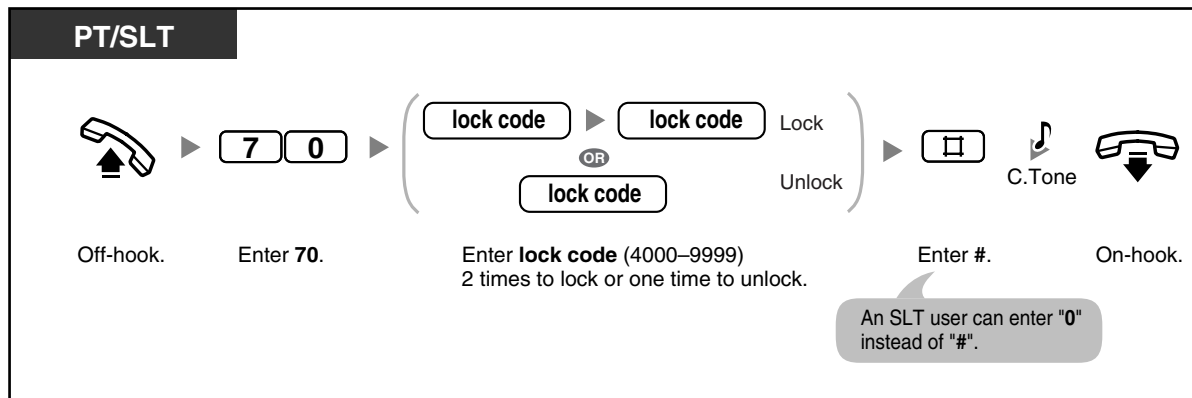

- The operator or manager can cancel this feature for all extensions (Extension Lock—CANCEL ALL). Even while this lock is on, you can confirm, call back, or clear message waiting indications left at your own extension.



Programming Manual References

[PC Programming]

- 9.2.2 Feature settings [2-2]—MW for Another Ext. Lock

Feature Manual References

- 1.1.83 Message Waiting for Another Extension

Operating Manual References

- 1.3.61 Message Waiting for Another Extension
- 2.1.7 System Feature Assignment—Extension Lock—CANCEL ALL

1.3.63 Microphone Mute

You can disable the microphone to consult privately with others in the room while listening to the other party on the phone through the speaker.



To set/cancel



- The AUTO ANS/MUTE button light shows the current status as follows:
 - Off:** Normal
 - Flashing red slowly:** Mute
- This feature is only available during a hands-free conversation.



Feature Manual References

- 1.1.84 Microphone Mute

1.3.64 One-touch Dialing

You can dial a phone number (max. 24 digits) previously stored to a flexible button with a one-touch operation.



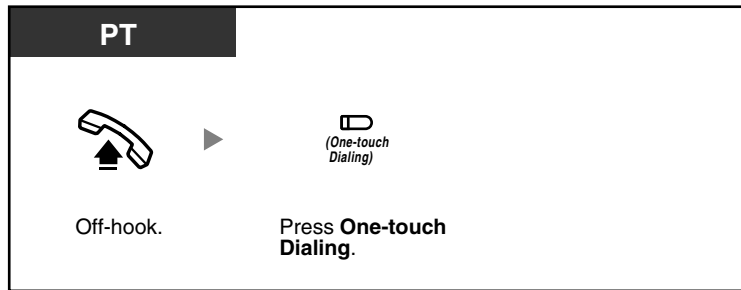

- A telephone number longer than 24 digits can be stored by dividing it among 2 or more One-touch Dialing buttons.
- You can confirm the stored number of a One-touch Dialing button by pressing it while on-hook.
- You can press a CO button to select a desired outside (CO) line before pressing the One-touch Dialing button.



Feature Manual References

- 1.1.86 One-touch Dialing

Operating Manual References

- 3.1.3 Flexible Button Assignment
Create or edit a One-touch Dialing button, store the desired phone number, or feature number.

1.3.65 Operator Call

You can easily call the extension assigned as the operator extension.

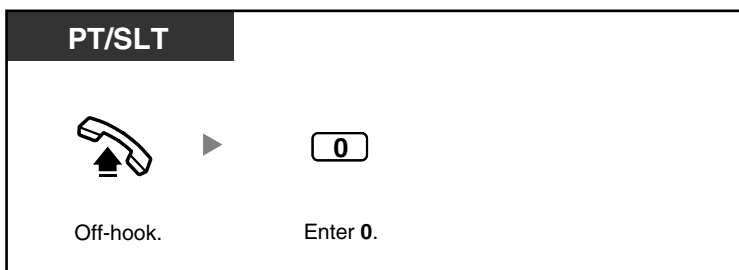

- If no operator is assigned, you will hear a reorder tone.

**Programming Manual References****[PT Programming]**

- [008] Operator Assignment

[PC Programming]

- 9.1.2 Main [1-2]—Operator

Feature Manual References

- 1.1.87 Operator/Manager Features

1.3.66 Paging—SUMMARY

You can make a paging announcement to several people at once. Your paging announcement can be heard through an external speaker and through the built-in speakers of proprietary telephones (PTs). An extension user can answer your paging announcement and establish an intercom call. There are 4 types of paging as shown below:

All Extensions:

Paging through the built-in speakers of all PTs.

All Extensions & External:

Paging through both the built-in speakers of all PTs and an external speaker.

External:

Paging through an external speaker.

Group:

Paging to a certain extension group through the built-in speakers of PTs.



- Only one person can use the Paging feature at a time. If someone is already using the Paging feature when you try to make a paging announcement, you will hear a busy tone.

**Programming Manual References****[PT Programming]**

- [106] External Pager Access Tone
- [600] Extension Group

[PC Programming]

- 9.1.11 Detail [1-10]—Extension—External Pager Access Tone
- 9.2.11 Extension Group [2-6]—Group No.

Feature Manual References

- 1.1.92 Paging—SUMMARY

Operating Manual References

- 1.3.71 Paging and Transfer
- 1.3.72 Paging Answer
- 1.3.73 Paging Deny

1.3.67 Paging—All Extensions

You can make a paging announcement to all extensions. Your paging announcement can be heard through the built-in speakers of all proprietary telephones (PTs).

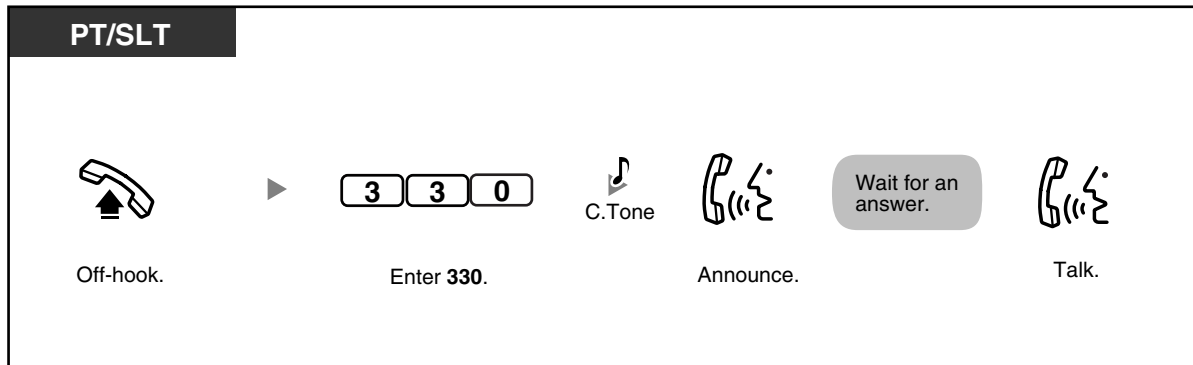

Feature Manual References

- 1.1.93 Paging—All Extensions

1.3.68 Paging—All Extensions & External

You can make a paging announcement to all extensions and over an external speaker. Your paging announcement can be heard through both the built-in speakers of all proprietary telephones (PTs) and an external speaker.

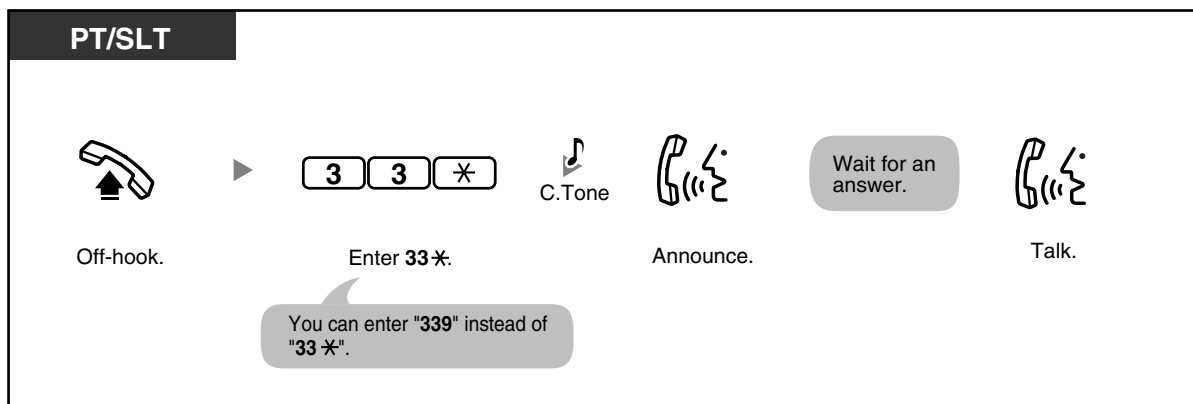

Programming Manual References

[PT Programming]

- [106] External Pager Access Tone

[PC Programming]

- 9.1.11 Detail [1-10]—Extension—External Pager Access Tone

Feature Manual References

- 1.1.94 Paging—All Extensions & External

1.3.69 Paging—External

You can make a paging announcement through an external speaker. Your paging announcement can be heard through an external speaker.

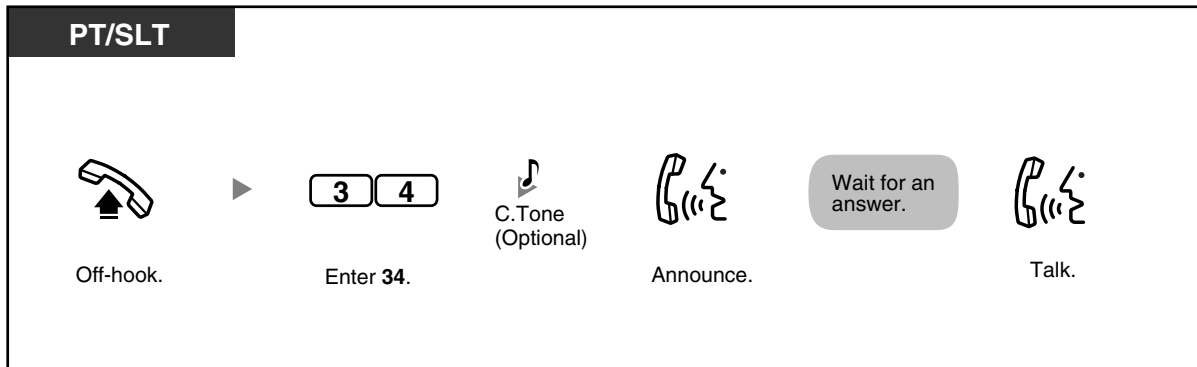

Programming Manual References

[PT Programming]

- [106] External Pager Access Tone

[PC Programming]

- 9.1.11 Detail [1-10]—Extension—External Pager Access Tone

Feature Manual References

- 1.1.95 Paging—External

1.3.70 Paging—Group

You can make a paging announcement to a certain extension group. Your paging announcement can be heard through the built-in speakers of the proprietary telephones (PTs) that belong to the certain extension group.

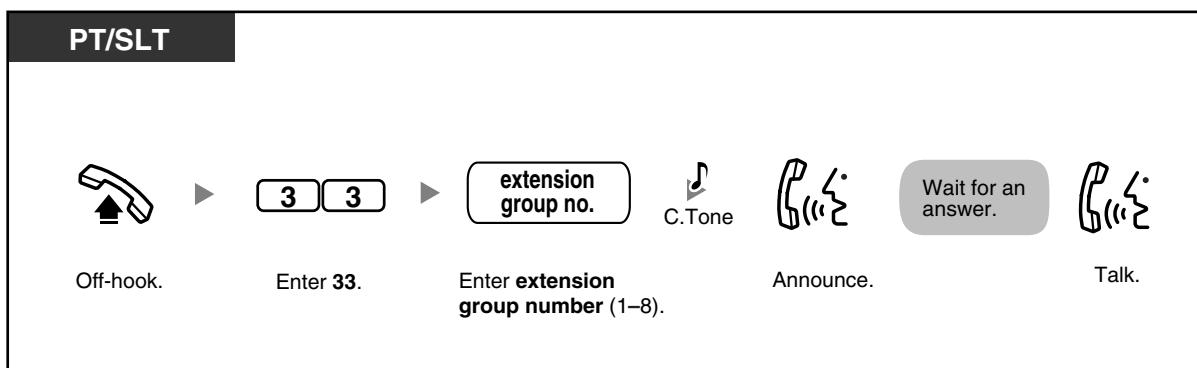



Programming Manual References

[PT Programming]

- [600] Extension Group

[PC Programming]

- 9.2.11 Extension Group [2-6]—Group No.

Feature Manual References

- 1.1.96 Paging—Group

1.3.71 Paging and Transfer

You can transfer a call after making a paging announcement.

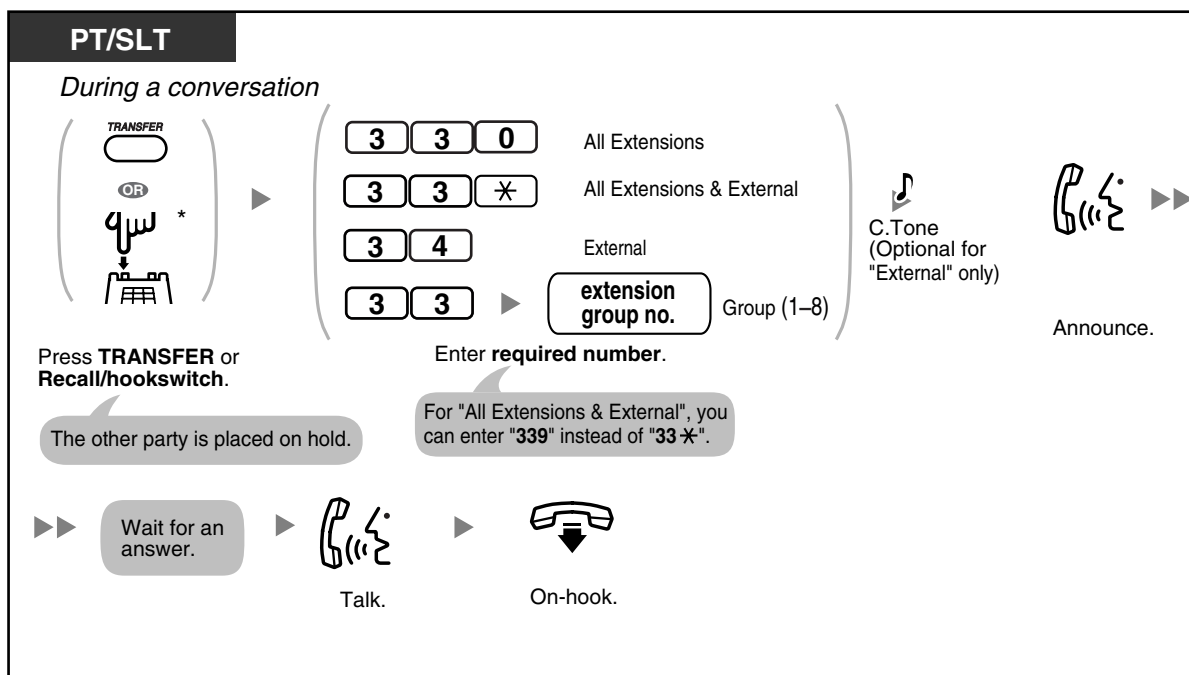

- * You may have to enter the Call Hold feature number, "20", after pressing the Recall/hookswitch on your single line telephone (SLT), depending on the SLT Hold Mode of your PBX. For more details, refer to "1.1.15 Call Hold" in the Feature Manual.
- After you go on-hook, the party on hold can talk to the person who answers the page.



Programming Manual References

[PT Programming]

- [104] SLT Hold Mode
- [106] External Pager Access Tone
- [600] Extension Group

[PC Programming]

- 9.1.11 Detail [1-10]—Extension—External Pager Access Tone, Single Line Telephone—Hold Mode
- 9.2.11 Extension Group [2-6]—Group No.

Feature Manual References

- 1.1.15 Call Hold
- 1.1.92 Paging—SUMMARY

1.3.72 Paging Answer

You can answer a paging announcement from any extension.

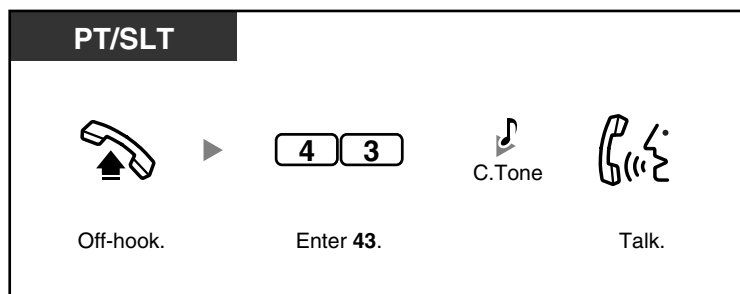

- When an outside (CO) line call is paged and transferred, you can answer the call by pressing the corresponding CO button whose indicator is flashing slowly.



Feature Manual References

- 1.1.92 Paging—SUMMARY

1.3.73 Paging Deny

You can set your proprietary telephone (PT) to not receive paging announcements.



To refuse/accept paging announcements

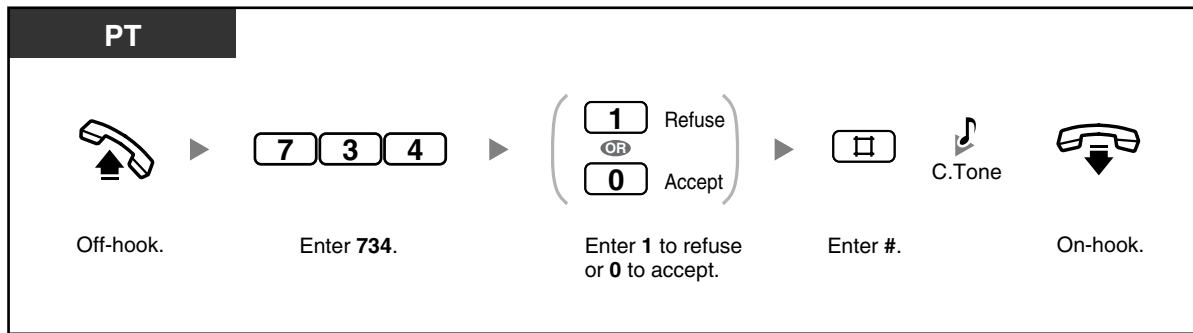

- The following are extensions that cannot receive paging announcements:
 - a PT that is ringing or busy
 - a PT in Paging Deny mode
 - a PT in Do Not Disturb (DND) mode



Programming Manual References

[PC Programming]

- 9.2.2 Feature settings [2-2]—Paging Deny

Feature Manual References

- 1.1.92 Paging—SUMMARY

1.3.74 Paralleled Telephone

Any proprietary telephone (PT) can be connected in parallel with a single line device, such as a single line telephone (SLT), fax machine, or modem.

When parallel mode is used, the 2 telephones function as follows:

- Both share one extension number.
- Either telephone or device can make or answer calls.

For more details, refer to "1.1.97 Paralleled Telephone" in the Feature Manual.



Feature Manual References

- 1.1.97 Paralleled Telephone

1.3.75 Personal Speed Dialing

You can store up to 10 numbers at your extension for your personal use. This feature is also known as Station Speed Dialing.

To store a phone number

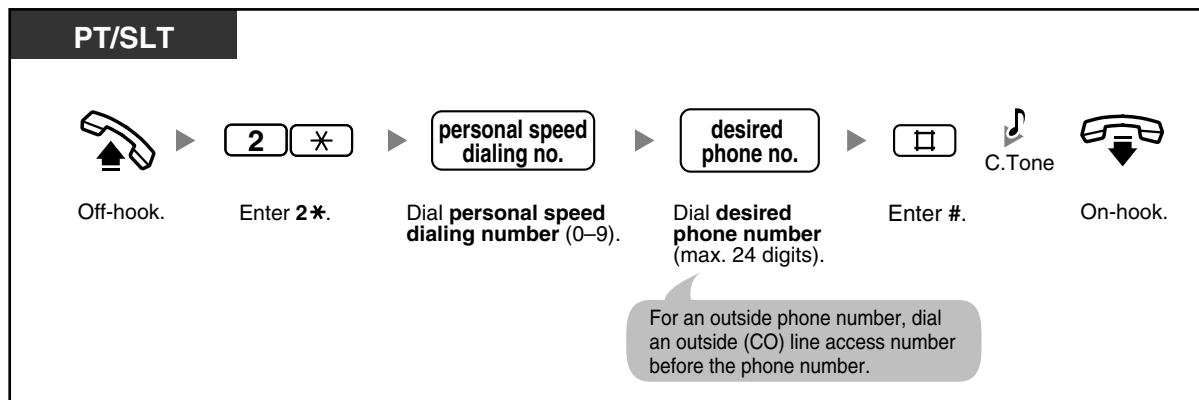

To dial

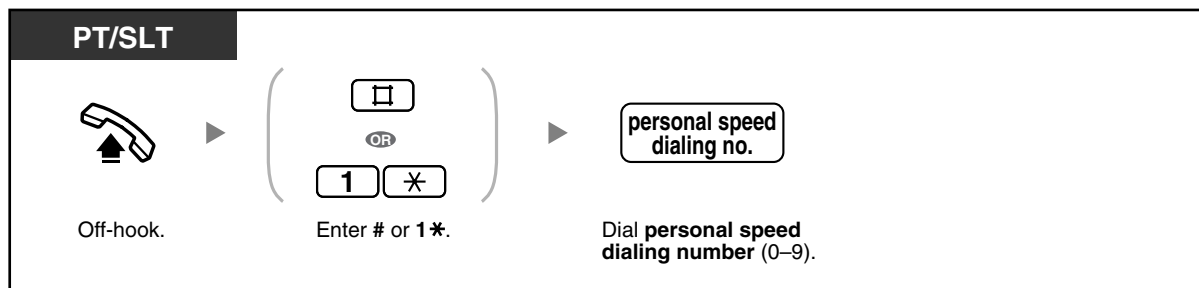

To confirm

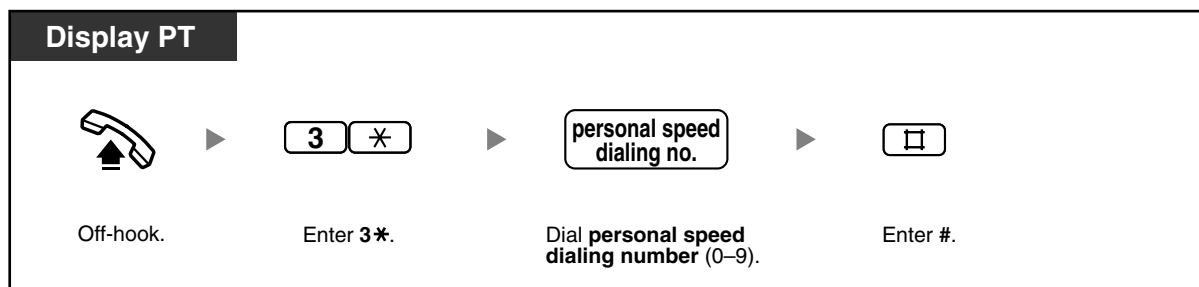

- Personal Speed Dialing numbers (0 through 9) correspond to the numbers (F1 through F10) of the Programmable Feature (PF) buttons assigned as One-touch Dialing numbers. Assigning a One-touch Dialing number to PF button "F1" will override Personal Speed Dialing number "0", and vice versa.
- Rotary single line telephone (SLT) users cannot use this feature.
- Up to 24 digits including "*" can be stored. However, depending on your mode of account code entry, "*" may not be regarded as a pause.



Feature Manual References

- 1.1.100 Personal Speed Dialing

Operating Manual References

- 3.1.3 Flexible Button Assignment
Create or edit a One-touch Dialing button, store the desired phone number, or feature number.

1.3.76 Power Failure Transfer

If the power supply to the PBX fails, specific single line telephones (SLTs) are automatically connected to specific outside (CO) lines (**Power Failure Connections**). The PBX will switch from the current connections to Power Failure Connections, and all existing conversations will be disconnected. Only outside (CO) line calls handled by Power Failure Connections can be made during a power failure. For more details, refer to "1.1.102 Power Failure Transfer" in the Feature Manual.



Feature Manual References

- 1.1.102 Power Failure Transfer

1.3.77 Pulse to Tone Conversion

If you are using a pulse-type outside (CO) line, you can temporarily change the dialing mode from pulse to tone to access computer telephone services that require tone dialing such as Voice Mail.

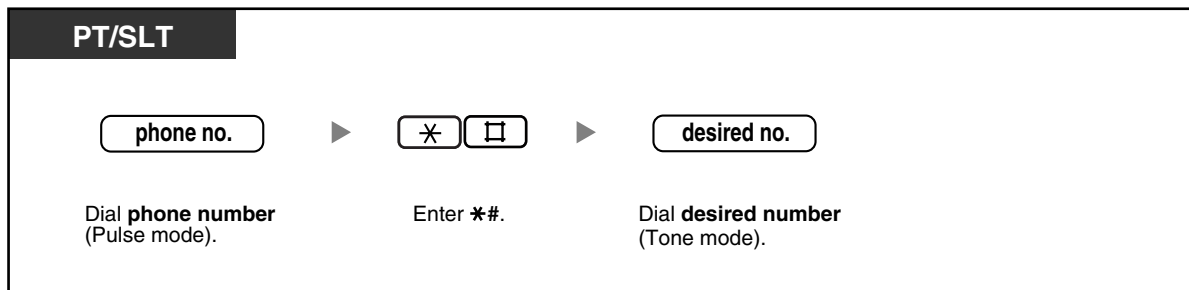

- You cannot change from tone to pulse dialing mode.



Programming Manual References

[PT Programming]

- [119] Redialing after Pulse to Tone Conversion
- [401] Dial Mode

[PC Programming]

- 9.1.11 Detail [1-10]—CO—Redialing after Pulse to Tone Conversion
- 9.3.3 Detail [3-3]—Dial Mode

Feature Manual References

- 1.1.104 Pulse to Tone Conversion

1.3.78 Redial, Last Number

Every extension automatically saves the last external telephone number dialed, allowing the same number to be easily redialed.

To dial

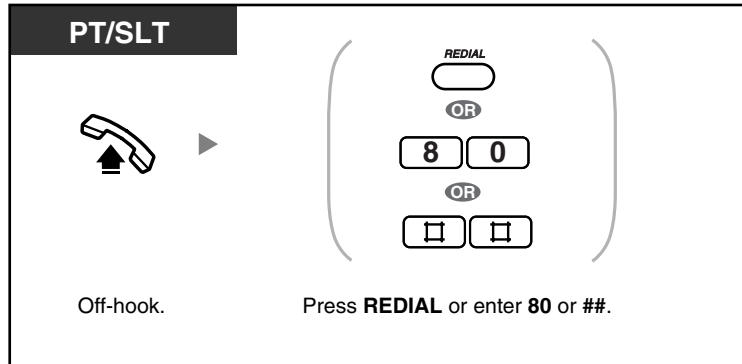

- Up to 64 digits, "×", "#", PAUSE, and SECRET (INTERCOM) (which stops all or part of the number from being displayed) can be stored and redialed. The outside (CO) line access number is not counted as a digit.
- If you hear a busy tone after pressing the REDIAL button, select another line and then press the REDIAL button or enter the feature number to retry.
- You can confirm the stored number by pressing the REDIAL button while on-hook.
- Pressing the REDIAL button after dialing a telephone number or during a conversation will disconnect the current call and redial the stored number.



Feature Manual References

- 1.1.105 Redial, Last Number

1.3.79 Redial, Saved Number

You can save a telephone number on your proprietary telephone (PT) while in a conversation with an outside party or while hearing a busy tone, and then easily redial the number later. The saved number remains available until another number is stored.



To save

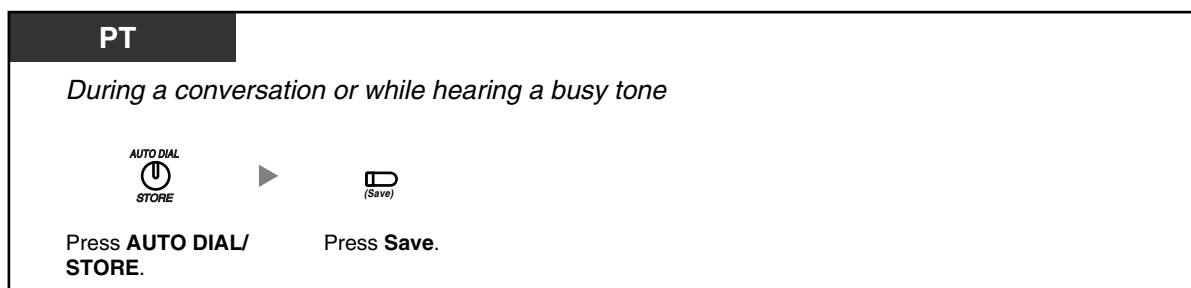

To dial



- Up to 64 digits, "*", "#", PAUSE, and SECRET (INTERCOM) (which stops all or part of the number from being displayed) can be stored and redialed. The outside (CO) line access number is not counted as a digit.
- If you hear a busy tone after pressing the Save button, select another line and then press the Save button to retry.
- You can confirm the stored number by pressing the Save button while on-hook.



Feature Manual References

- 1.1.106 Redial, Saved Number

Operating Manual References

- 3.1.3 Flexible Button Assignment
Create or edit a Save button.

1.3.80 Room Monitor

You can monitor a room through another proprietary telephone (PT), or monitor a door through a doorphone. The PT you want to monitor should be set in advance to allow monitoring.

To set

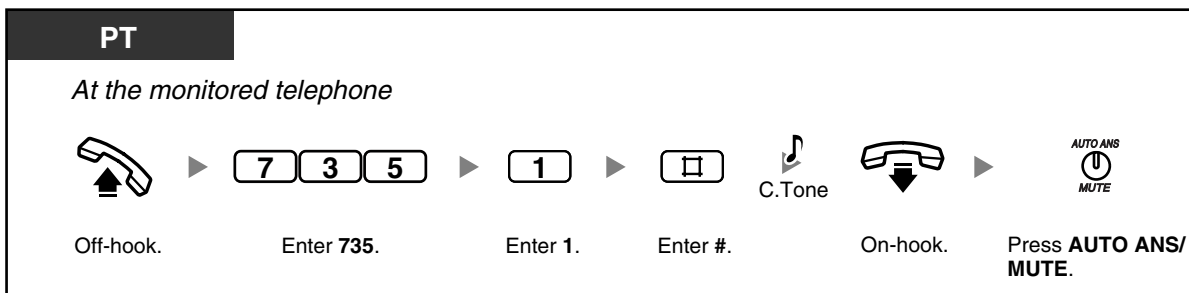

To monitor

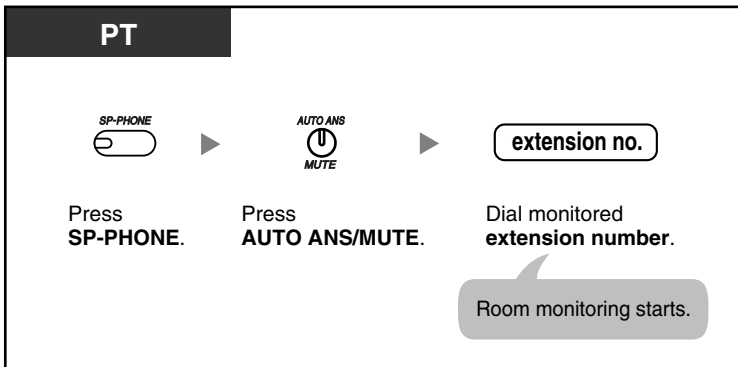

To monitor through a doorphone

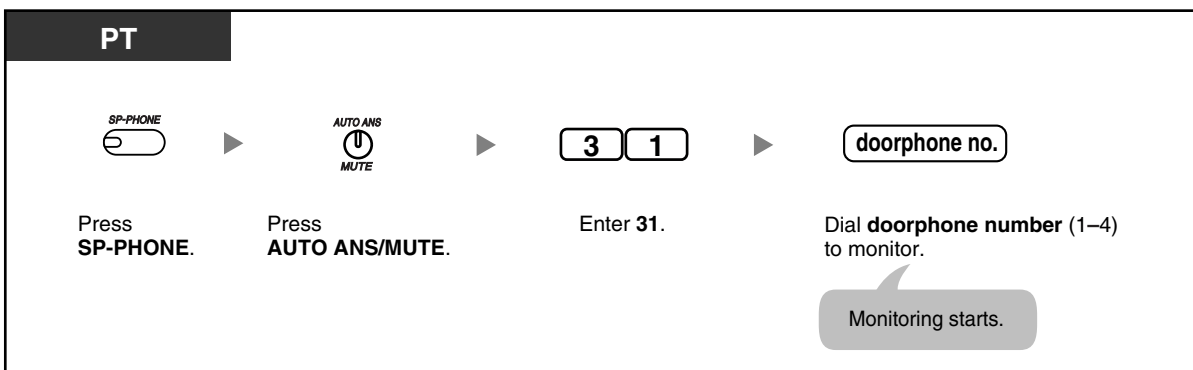

To talk with a person in the monitored room

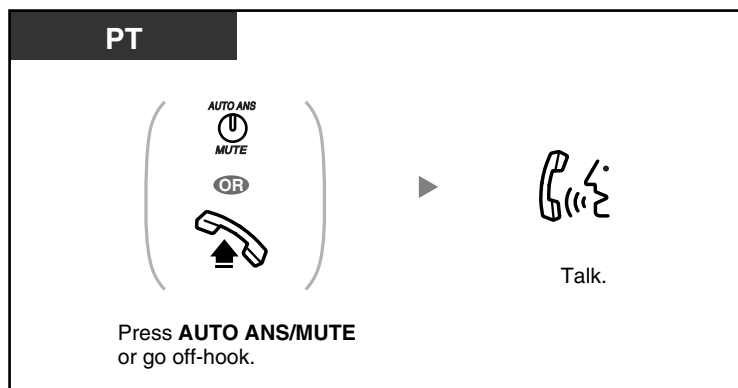

To cancel a monitor

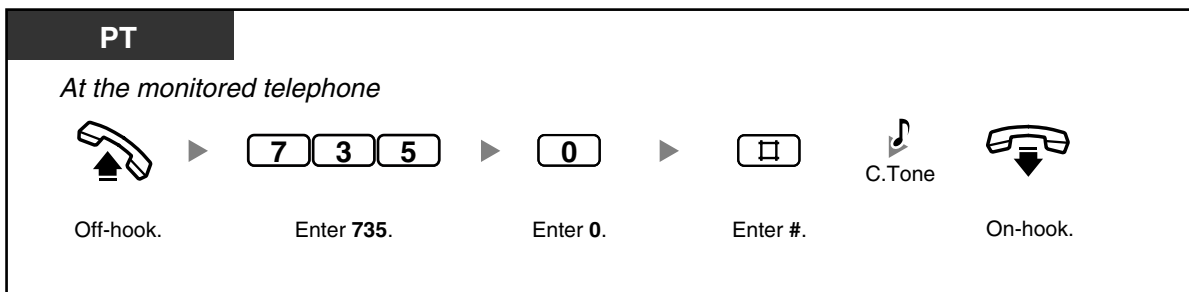

To stop a monitor temporarily while on-hook

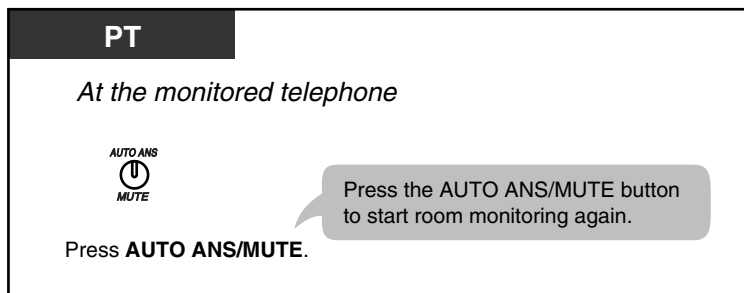

- You can monitor using a PT with an **AUTO ANS/MUTE** button or a single line telephone (SLT) with a **MUTE** button.
- The **AUTO ANS/MUTE** button light shows the current status as follows:
Off: Not set
Flashing red: Set (Ready for monitoring)

Programming Manual References

[PT Programming]

- [612] Room Monitor
- [707] Doorphone Access Tone

[PC Programming]

- 9.2.1 Main [2-1]—Room Monitor
- 9.2.2 Feature settings [2-2]—Monitored PT set
- 9.7.2 Others [7-2]—Doorphone Access Tone—Door 1–4

Feature Manual References

- 1.1.110 Room Monitor

1.3.81 Secret Dialing

You can prevent all or part of a System Speed Dialing number or One-touch Dialing number from being displayed when making a call, by pressing the **INTERCOM** button at the beginning and at the end of the number to be hidden.



Display PT

When storing the phone number

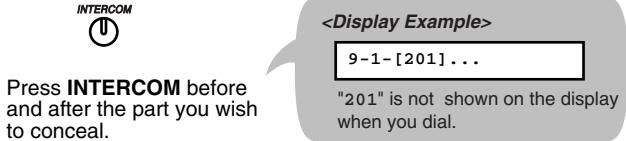

Press **INTERCOM** before and after the part you wish to conceal.

<Display Example>
9-1-[201]...
"201" is not shown on the display when you dial.



- The characters for secret code, "[" and "]" (entered by pressing the INTERCOM button), are counted as one digit each.
- You can conceal one or more parts of a telephone number.
- It is not possible to hide the Outside (CO) Line Access number (9, or 81 through 88) by pressing the INTERCOM button before dialing it.
- It is programmable whether the hidden part of the number will be shown on SMDR.



Programming Manual References

[PT Programming]

- [001] System Speed Dialing Number
- [803] Secret Number SMDR Print Suppression

[PC Programming]

- 9.1.8 SMDR [1-7]—Selection for Printing—Secret Number
- 9.4.1 System Speed Dialing [4-1]—Line Access Number + Telephone Number

Feature Manual References

- 1.1.111 Secret Dialing

Operating Manual References

- 1.3.64 One-touch Dialing
- 1.3.82 System Speed Dialing
- 3.1.3 Flexible Button Assignment
Create or edit a One-touch Dialing button, store the desired phone number, or feature number.

1.3.82 System Speed Dialing

You can make calls using preprogrammed speed dialing numbers (max. 100 codes) stored in the PBX.

PT/SLT

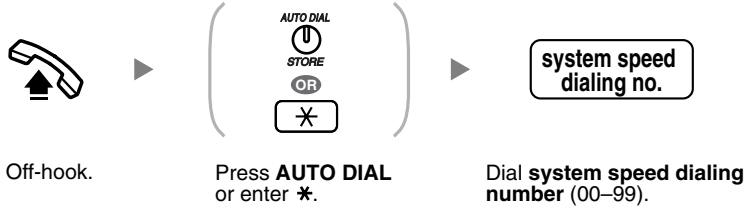

Off-hook.

Press **AUTO DIAL** or enter *****.

Dial **system speed dialing number** (00–99).



- A telephone number longer than 32 digits can be stored by dividing it among 2 or more System Speed Dialing buttons.

<Example>

If the number is divided and stored in system speed dialing numbers 01 and 02:



- Rotary single line telephone (SLT) users cannot use this feature.
- You can press a CO button to select a desired outside (CO) line before pressing the AUTO DIAL/STORE button.



Programming Manual References

[PT Programming]

- [001] System Speed Dialing Number
- [011] System Speed Dialing Name
- [301] TRS—System Speed Dialing Class

[PC Programming]

- 9.4 System Speed Dialing [4]
- 9.5.4 Emergency Number & Others [5-4]—System Speed Dialing Class

Feature Manual References

- 1.1.113 System Speed Dialing

1.3.83 Time Service

The PBX can be programmed to make and receive calls differently in day/night/lunch modes. You can confirm the current time service mode (day, night, or lunch) on the display of your proprietary telephone (PT) while on-hook.



No SLT

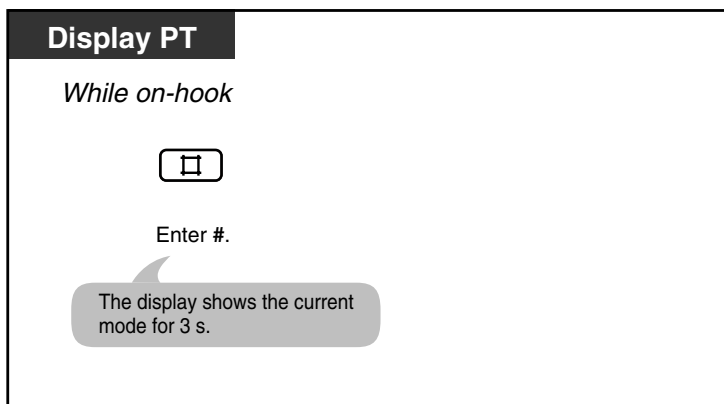

- Time Service can only be set by the operator or manager. Refer to "2.1.9 Time Service".



Programming Manual References

[PT Programming]

- [006] Time Service Switching Mode
- [007] Time Service Start Time

[PC Programming]

- 9.1.4 Time Service [1-4]
- 9.1.5 Time Service [1-4] Time Setting

Feature Manual References

- 1.1.114 Time Service

Operating Manual References

- 2.1.9 Time Service

1.3.84 Timed Reminder

You can set your telephone to ring at a set time, to remind you of a meeting, appointment, or as a wake-up call. The alarm can occur either one time or daily (every day until canceled) at a preset time. When you go off-hook to answer, you hear a special dial tone (dial tone 3).

To set

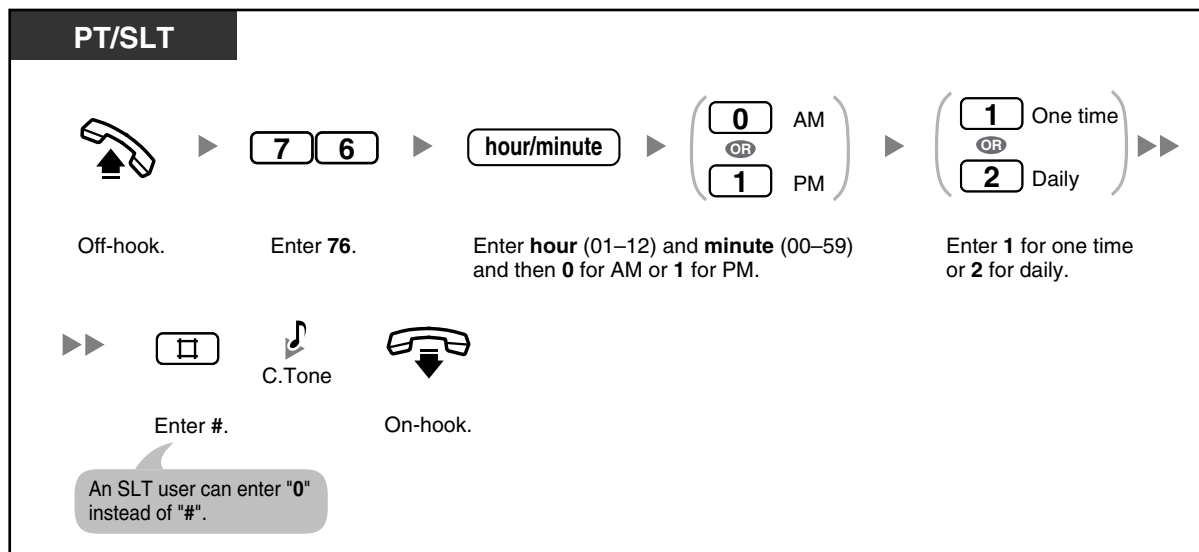

To cancel

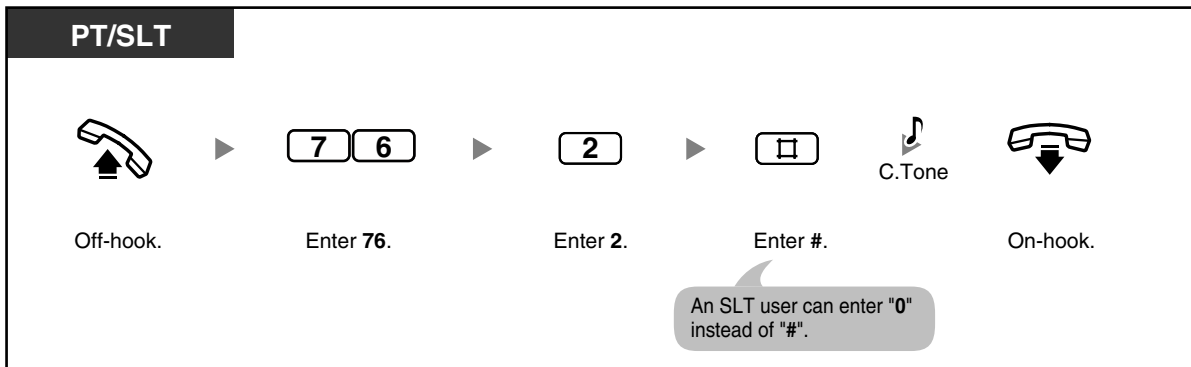

To stop the alarm

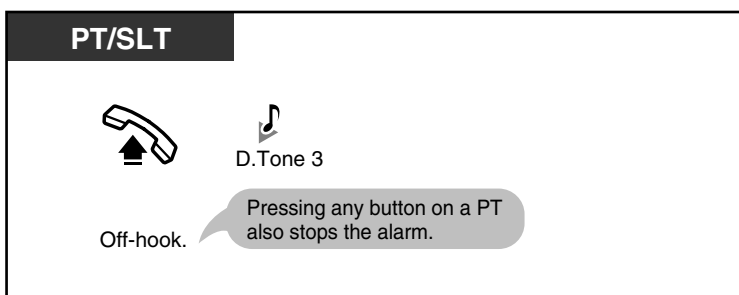

To confirm

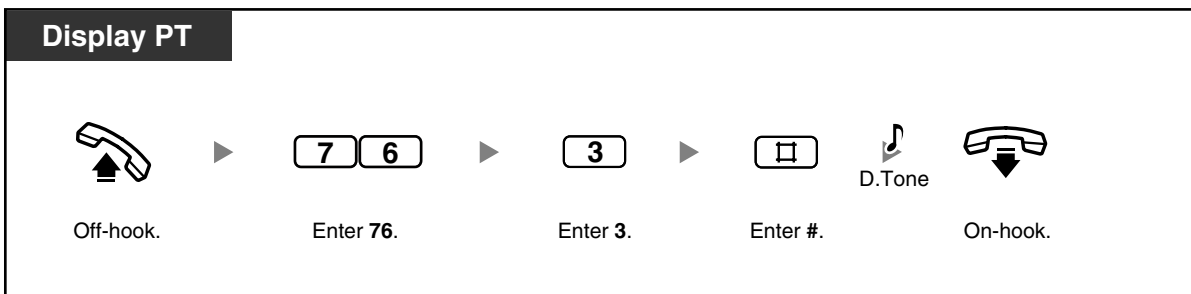

- The alarm rings for 30 seconds.
- **If you receive an incoming call during an alarm**, the ringing for that call will start after the alarm stops ringing.
- If the telephone is off-hook at the time an alarm is scheduled to ring, the alarm will start after the telephone goes on-hook again.

**Programming Manual References****[PT Programming]**

- [000] Date & Time

[PC Programming]

- 9.1.1 Date & Time [1-1]
- 9.2.2 Feature settings [2-2]—Timed Reminder

Feature Manual References

- 1.1.115 Timed Reminder

Operating Manual References

- 2.1.10 Timed Reminder, Remote (Wake-up Call)

1.3.85 Toll Restriction (TRS)

Toll Restriction (TRS) can prohibit certain extension users from making unauthorized outside (CO) line calls. Every extension is assigned to one of 5 classes of service (COSs) for each time service mode through system programming; COS 1 grants the highest level of authorization, allowing all outside (CO) line calls to be made, and COS 5 grants the lowest level of authorization. COSs 2 through 5 are used to restrict calls with a combination of preprogrammed Denied and Exception Code Tables. For more details, refer to "1.1.117 Toll Restriction (TRS)".

**Feature Manual References**

- 1.1.117 Toll Restriction (TRS)

1.3.86 Toll Restriction (TRS) Override by Account Code

You can override TRS temporarily to make a toll call from a toll-restricted telephone. You can carry out this feature by entering the appropriate account code before dialing the telephone number. For more details, refer to "1.1.118 Toll Restriction (TRS) Override by Account Code".

**Feature Manual References**

- 1.1.118 Toll Restriction (TRS) Override by Account Code

1.3.87 Two-way Recording in the VPS (Voice Mail APT Integration only)

You can record a conversation into a mailbox while talking on the phone. You can select the mailbox each time you record a conversation. This feature is available when the PBX is connected to a Panasonic Voice Processing System (VPS) that supports APT integration.

**No SLT**

To record into your mailbox (2-way Record)



To record into another mailbox (2-way Transfer)

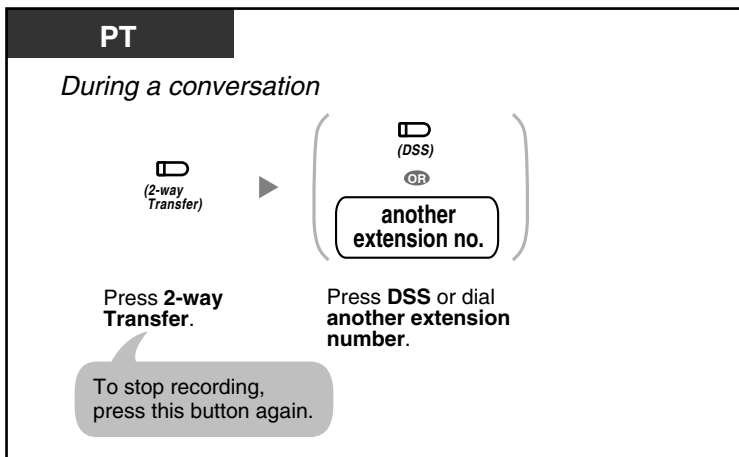

- The 2-way Record button light or 2-way Transfer button light shows the current status as follows:
Off: Not recording.
On: Recording the conversation.



- Note:**
When you record your 2-way telephone conversations, you should inform the other party that the conversation is being recorded.



Feature Manual References

- 1.1.119 Two-way Recording into the VPS (Voice Mail APT Integration only)
- 1.1.120 Voice Mail APT Integration

Operating Manual References

- 3.1.3 Flexible Button Assignment
Create or edit a 2-way Record button, 2-way Transfer button, or Direct Station Selection (DSS) button.

1.3.88 Voice Mail Integration

You or an outside party can access the Voice Processing System (VPS) from a telephone. If you cannot answer calls, you can set them to be forwarded to your mailbox in a Panasonic VPS that supports either

Inband (DTMF) Integration (e.g., KX-TVA/KX-TVS series VPS) or APT Integration (e.g., KX-TVA50/KX-TVS50/KX-TVS90 VPS). If your telephone has a MESSAGE button or Message/Ringer Lamp, the corresponding button or lamp turns on and lets you know you have messages. A single line telephone (SLT) user will hear dial tone 3 when going off-hook if there are any messages in his or her mailbox.

To set/cancel

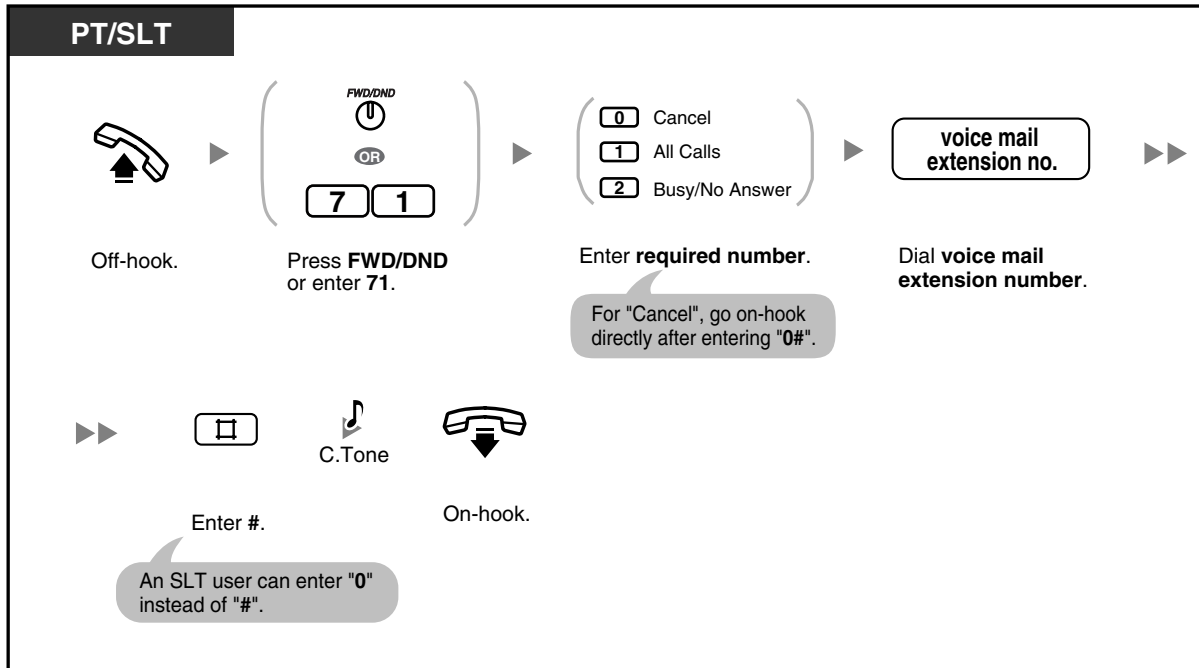

- If your PBX has a Panasonic VPS connected using Inband (DTMF) integration, your PBX automatically sends a special signal to the Voice Mail port before connecting the caller. To enable this feature, it may be necessary to set the signal format required by your VPS before setting the Call Forwarding (FWD) destination to Voice Mail as follows:
 - Setting A: only sends the extension number to the Voice Mail port. To set or cancel, enter "91#" or "90#" respectively after pressing the FWD/DND button or entering "71".
 - Setting B (default): sends "#6" followed by the extension number. "#6" is used by a Panasonic KX-TVA/KX-TVS series VPS to force the VPS port into voice mail service. To set or cancel, enter "92#" or "90#" respectively after pressing the FWD/DND button or entering "71".
 For more details, refer to "1.1.121 Voice Mail Inband (DTMF) Integration" in the Feature Manual.

To listen to messages

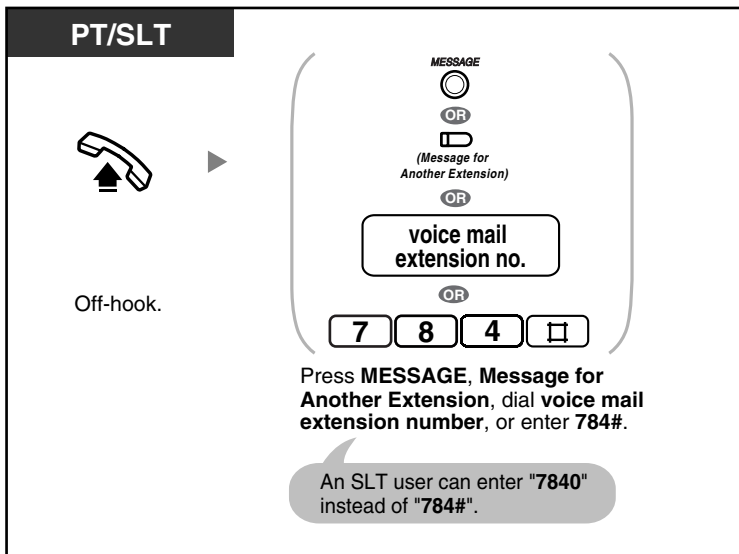

- If a proprietary telephone (PT) user sets the FWD—Busy/No Answer feature, the FWD/DND button light will keep flashing while on-hook. To stop the button from flashing, go off-hook and enter "716#".



Programming Manual References

[PT Programming]

- [009] Extension Number
- [100] Hunting Group Set
- [101] Hunting Type
- [102] DTMF Integration Port
- [103] DTMF Integration
- [130] VM 1 APT Port
- [131] VM 2 APT Port
- [408-410] Flexible Ringing—Day/Night/Lunch
- [411-413] Delayed Ringing—Day/Night/Lunch
- [414-416] CO Line Mode—Day/Night/Lunch
- [507] DISA Intercept Mode
- [600] Extension Group

[PC Programming]

- 9.1.2 Main [1-2]—Voice Mail
- 9.1.3 Numbering Plan [1-3]—Ext. no.
- 9.2.2 Feature settings [2-2]—FWD/DND, Voice Mail Integration
- 9.2.11 Extension Group [2-6]
- 9.3.1 Line Mode [3-1]—Mode of incoming CO calls—Day, Night, Lunch
- 9.3.2 Incoming / Outgoing [3-2]—Ringling for incoming CO calls—Day, Night, Lunch
- 9.6.3 Settings [6-2]—Mode—DISA Intercept Mode

Feature Manual References

- 1.1.120 Voice Mail APT Integration
- 1.1.121 Voice Mail Inband (DTMF) Integration

Operating Manual References

- 1.3.10 Call Forwarding (FWD)—All Calls
- 1.3.11 Call Forwarding (FWD)—Busy/No Answer
- 3.1.3 Flexible Button Assignment
Create or edit an FWD/DND (Call Forwarding/Do Not Disturb) button or Message button.

1.3.89 Voice Mail Transfer (Voice Mail APT Integration only)

You can transfer received outside (CO) line calls to a mailbox so that calling parties can leave messages. If you create a Voice Mail Transfer button on your phone, you can transfer calls to a desired extension without having to enter the mailbox number.

The maximum recording time for caller messages depends on the Voice Processing System (VPS).

This feature is available when the PBX is connected to a Panasonic VPS that supports APT integration.

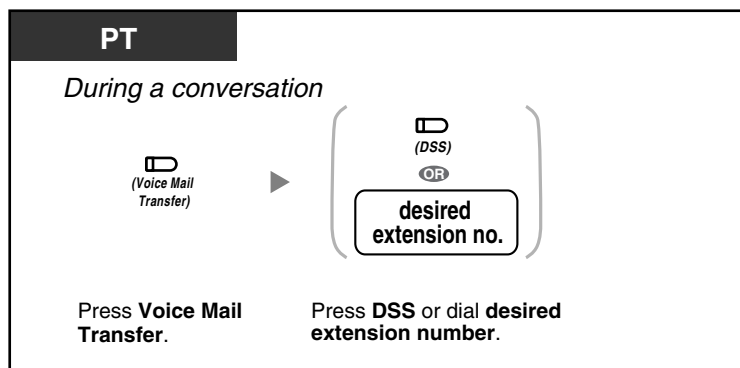

No SLT

To transfer a call to a mailbox**Feature Manual References**

- 1.1.120 Voice Mail APT Integration

Operating Manual References

- 3.1.3 Flexible Button Assignment
Create or edit a Voice Mail (VM) Transfer button or Direct Station Selection (DSS) button.

1.3.90 Walking COS

You can use your calling privileges (class of service [COS]) at another extension, to override calling restrictions that have been set at that extension. To use this feature, a preprogrammed extension password is required. Ask your manager for the extension password.

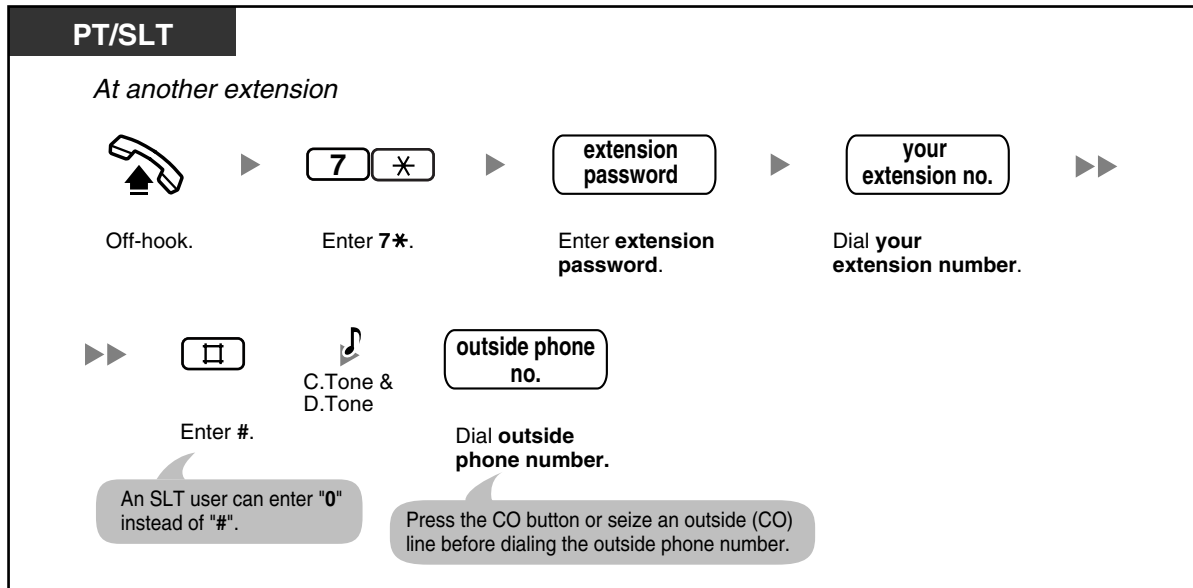

- Rotary single line telephone (SLT) users cannot use this feature.



Programming Manual References

[PT Programming]

- [601-603] TRS-COS—Day/Night/Lunch

[PC Programming]

- 9.5.1 Class of Service (COS) [5-1]—Day, Night, Lunch

Feature Manual References

- 1.1.117 Toll Restriction (TRS)
- 1.1.122 Walking COS

Operating Manual References

- 2.1.7 System Feature Assignment—Extension Password Set (Manager only)

Section 2

Operator/Manager Operation

This chapter shows the operator and the manager extension how to control the other extensions or the PBX. Your PBX supports one manager (extension jack 01) and one operator.

2.1 Operator/Manager Service Features

2.1.1 Call Log, Incoming in the Common Area—CLEAR ALL

The operator or manager can erase all caller information logged in the common area.



To erase

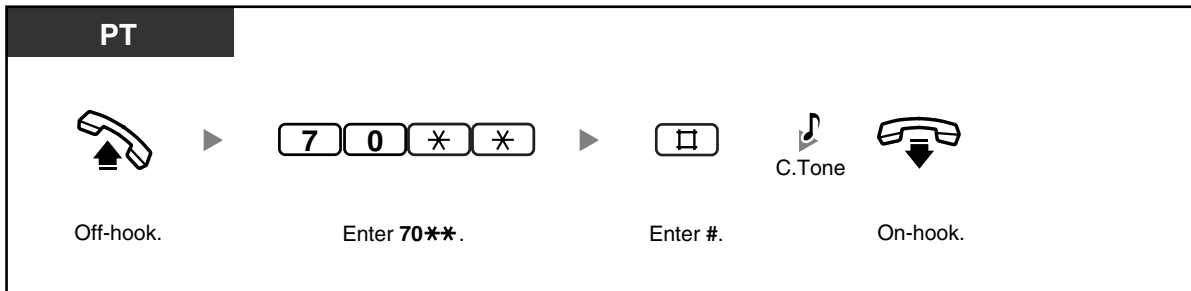

- Caller information with associated voice messages is not erased by this operation.
- This feature is not available while someone is viewing caller information logged in the common area.



Feature Manual References

- 1.1.18 Call Log, Incoming
- 1.1.87 Operator/Manager Features

2.1.2 Call Log Display Lock, Incoming in the Common Area

The operator or manager can lock the displays of proprietary telephones (PTs) so that the Call Log, Incoming feature is not shown on the display when the Caller ID Indication—Common button is pressed. This can be useful to prevent other people from viewing caller information logged in the common area.

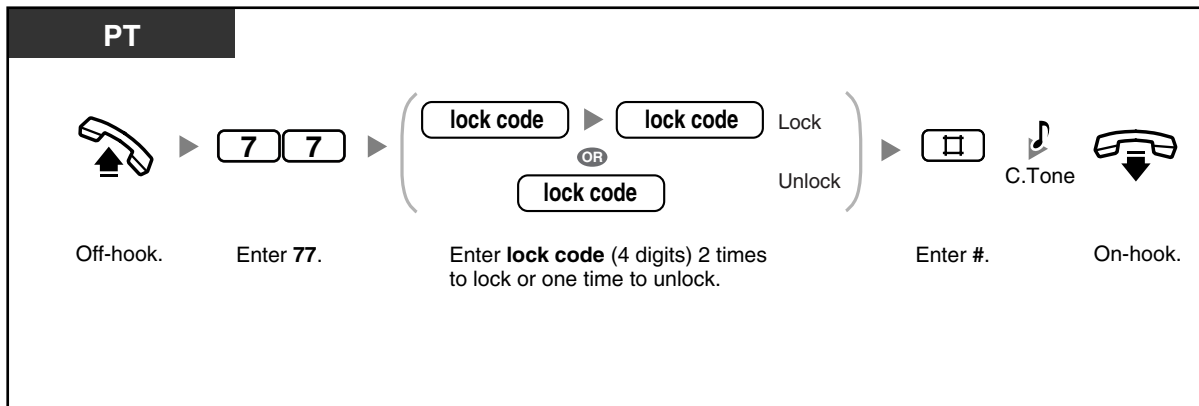

To lock/unlock

**Feature Manual References**

- 1.1.18 Call Log, Incoming
- 1.1.87 Operator/Manager Features

Operating Manual References

- 1.3.18 Call Log, Incoming
- 1.3.19 Call Log Display Lock, Incoming in the Personal Area

2.1.3 Common BV Outgoing Messages

If an optional voice message card is installed in the PBX, the operator or manager can record, play, or erase a common Built-in Voice Message (BV) outgoing message (OGM) in the common message area. When an outside (CO) line call is automatically directed to the common message area, or when a Direct Inward System Access (DISA) call is redirected to the common message area via Intercept Routing, the caller will hear a common BV OGM and can leave a voice message. To play back or erase the voice message, refer to "1.3.7 Built-in Voice Message (BV)".

To record

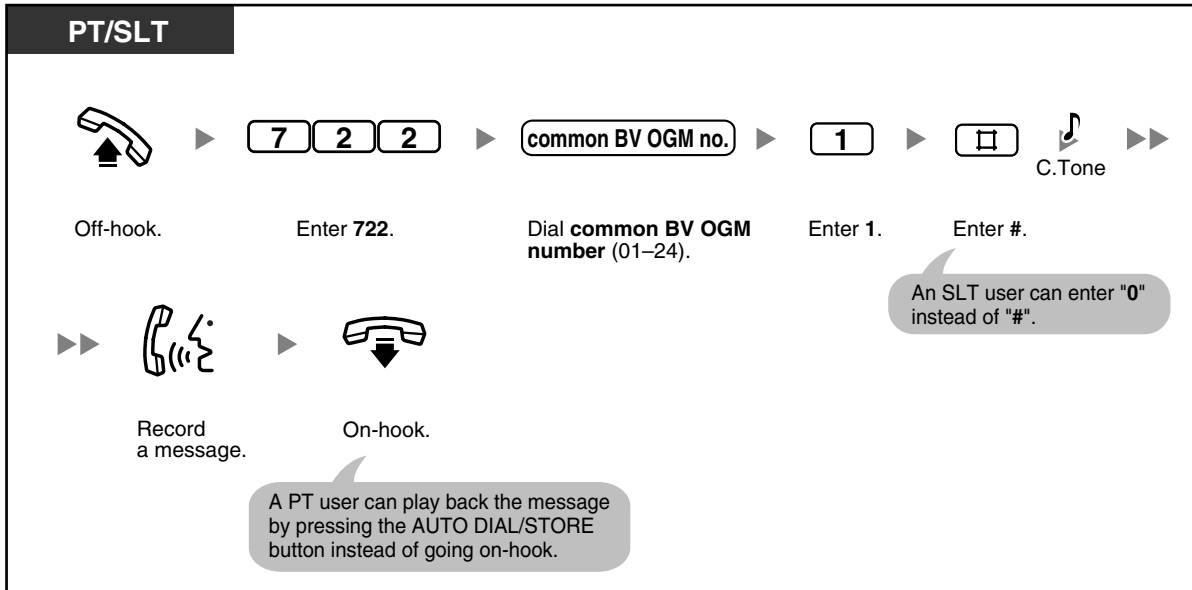

To play back

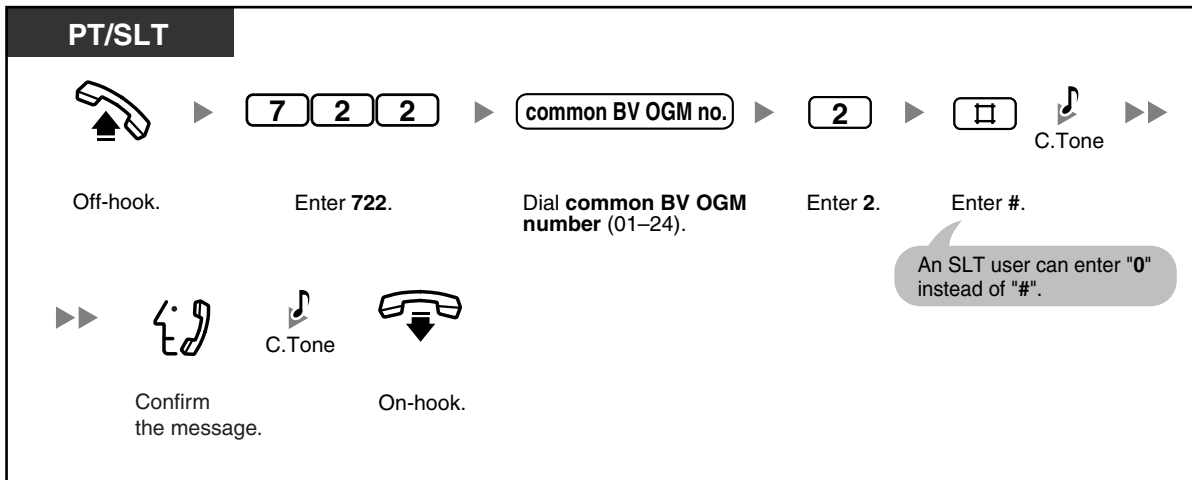

- The AUTO DIAL/STORE button light shows the current status as follows:
Off: You are recording a message, or a message has finished playing.
Red on: A message is playing.
- You can stop playback by pressing the AUTO DIAL/STORE button.

To erase

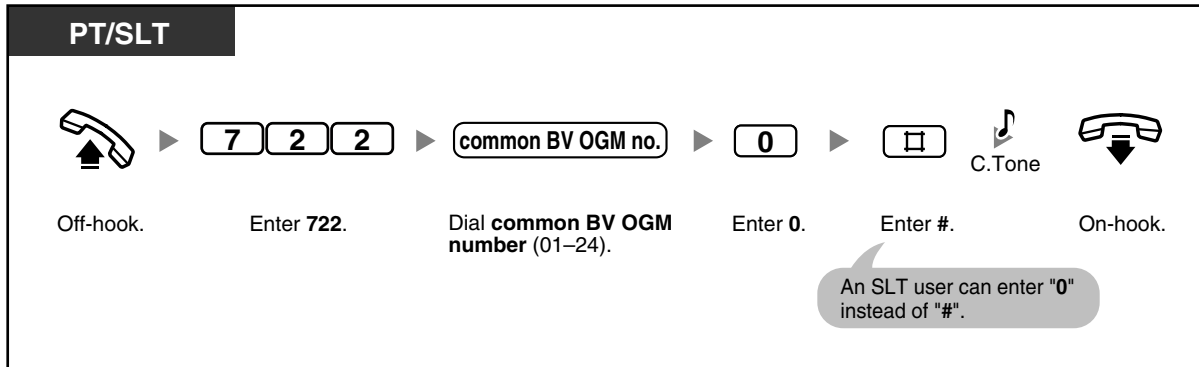

- You can lock your extension so that other people cannot access the common message area using your telephone. Refer to "1.3.44 Extension Lock".

**Feature Manual References**

- 1.1.8 Built-in Voice Message (BV)
- 1.1.87 Operator/Manager Features

Operating Manual References

- 1.3.7 Built-in Voice Message (BV)
- 1.3.44 Extension Lock

2.1.4 Manager Programming (Manager only)

The manager can program the following system programming with the manager password even if he or she does not know the system password for system programming. For more details, refer to "3.2 System Programming (Manager Programming)" in this manual.

- [001] System Speed Dialing Number
- [011] System Speed Dialing Name
- [512] DISA Security Code
- [530] DISA Security Code Digits



Programming Manual References

[PT Programming]

- [001] System Speed Dialing Number
- [011] System Speed Dialing Name
- [512] DISA Security Code
- [530] DISA Security Code Digits

[PC Programming]

- 9.4 System Speed Dialing [4]
- 9.6.3 Settings [6-2]—Security—DISA Security Codes, Security—DISA Security Code Length

Feature Manual References

- 1.1.87 Operator/Manager Features

Operating Manual References

- 2.1.7 System Feature Assignment—Extension Password Set (Manager only)
- 3.2 System Programming (Manager Programming)

2.1.5 Outgoing Message (OGM) for DISA

The operator or manager can record, play, or erase OGMs used by Direct Inward System Access (DISA) and 3-level Automated Attendant (AA).



To record OGMs for DISA

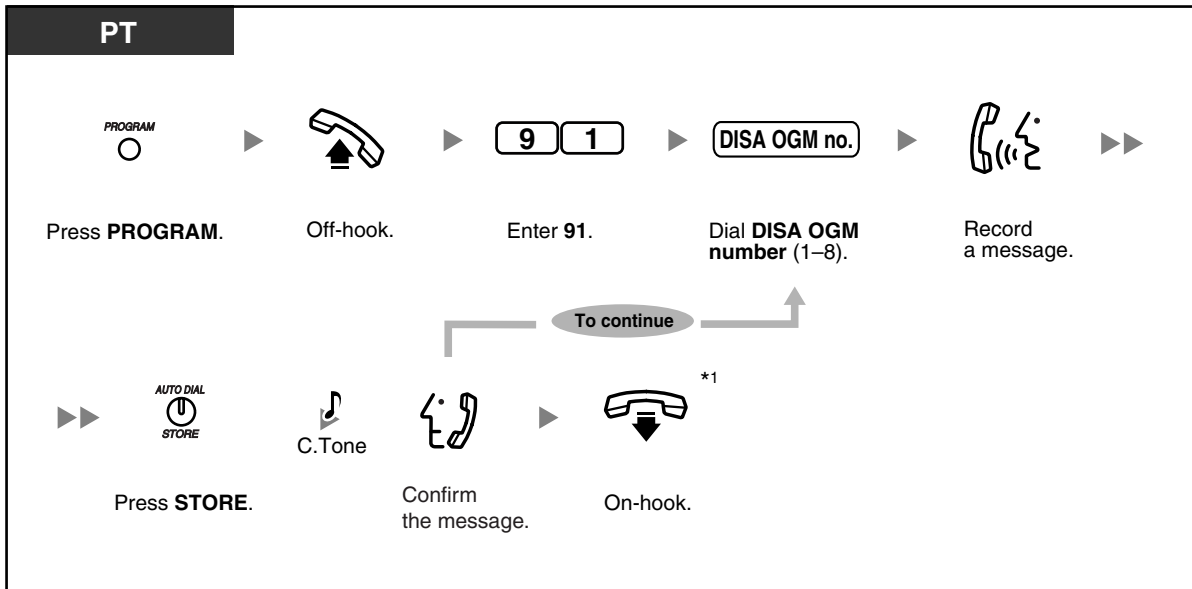

To play back OGMs for DISA

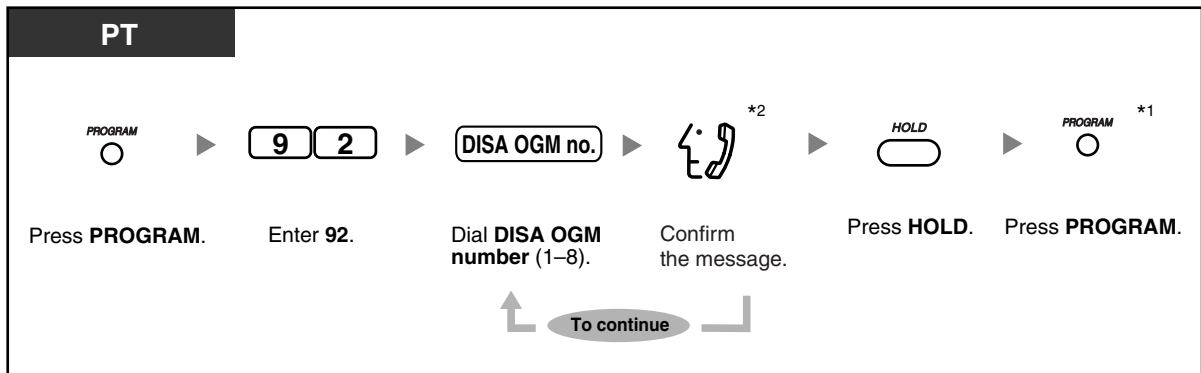

To erase OGMs for DISA

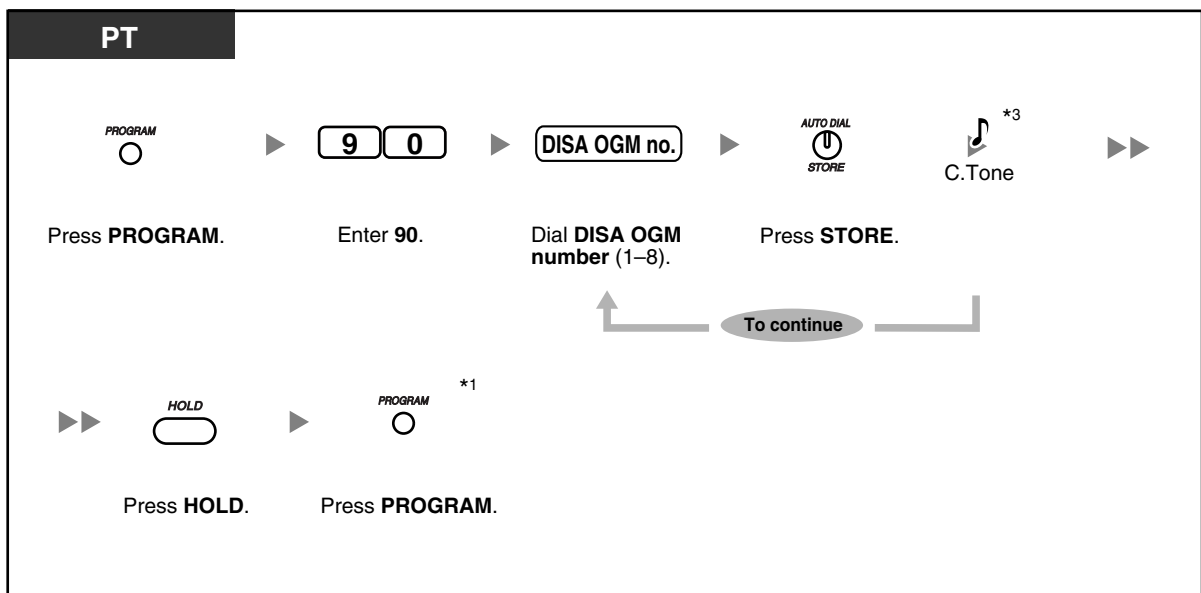

To record OGMs for 3-level AA

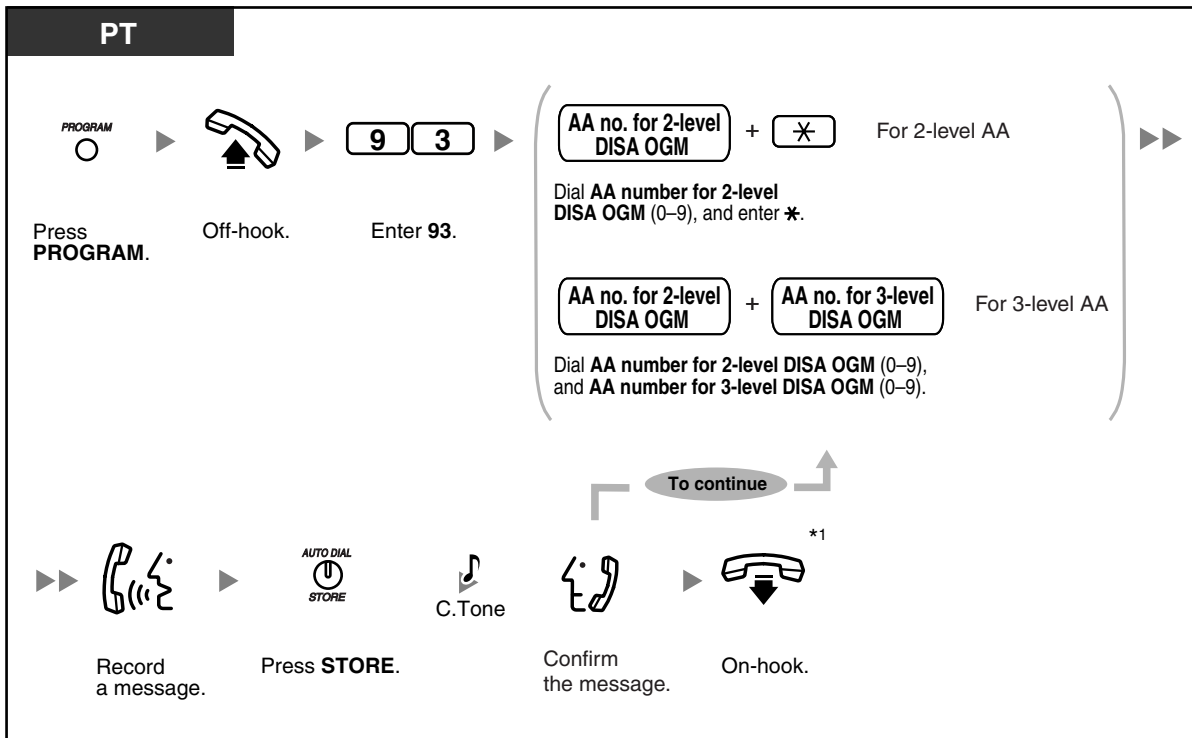

To play back OGMs for 3-level AA

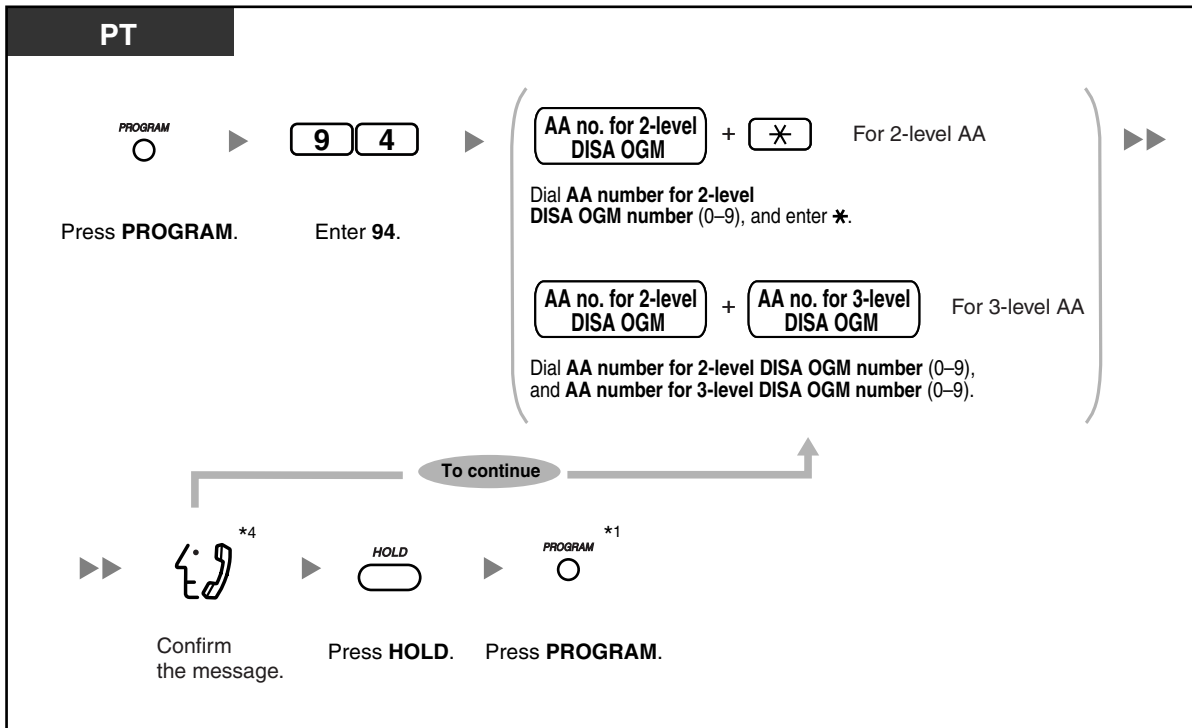



- Up to 32 messages (DISA: max. 8, 3-level AA: max. 24) can be recorded. A message can be up to 3 minutes long. The total recording time of the PBX for DISA OGMs is 3 minutes. When an optional message expansion card for DISA OGMs is added, the total recording time of the PBX is increased to 6 minutes. When the total time of all recordings becomes 3 (or 6) minutes or more, the PBX automatically stops recording. Record messages using the handset (not the Hands-free microphone), to reduce background noise.
- *1 To exit programming mode after the message has played, press the HOLD button and then the PROGRAM button, or go off-hook and then on-hook.
- *2 While the message is being played back, you can enter "0", "1", or "2", to erase, record, or play any OGMs for DISA, or press the SP-PHONE (NEXT) or REDIAL (PREV) button to start playing other OGMs for DISA.
- *3 "Delete Complete" is shown on a display proprietary telephone (PT). While this message is shown, you can enter "0", "1", or "2", to erase, record, or play any OGMs for DISA.
- *4 While the message is being played back, you can enter "3" or "4", to record or play any OGMs for 3-level AA, or press the SP-PHONE (NEXT) or REDIAL (PREV) button to start playing other OGMs for 3-level AA.



Feature Manual References

- 1.1.87 Operator/Manager Features
- 1.1.88 Outgoing Message (OGM) for DISA

Operating Manual References

- 1.3.34 Direct Inward System Access (DISA)

2.1.6 Remote Extension Lock

The operator or manager can lock or unlock an extension.
This feature is also known as Remote Station Lock Control.



To lock/unlock

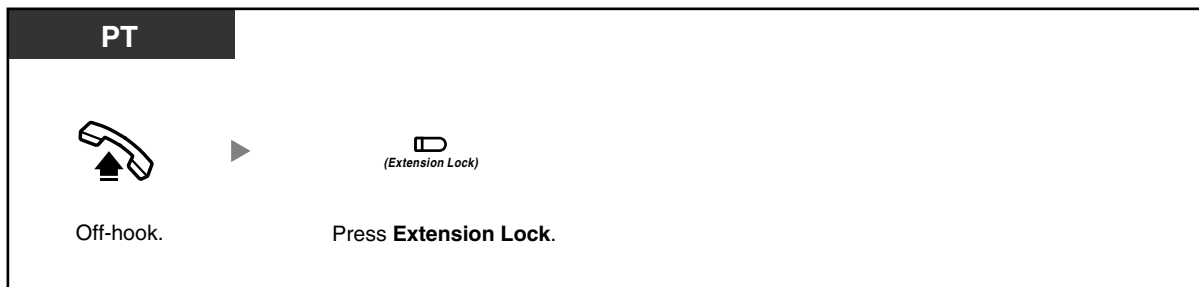



- This feature overrides the Extension Lock feature. If Extension Lock has already been set by the extension user and this feature is set afterwards, the extension user cannot cancel the lock. Only the operator or manager can cancel the lock.
- The Extension Lock—CANCEL ALL feature can cancel all locks placed on extensions using this feature. Refer to "2.1.7 System Feature Assignment—Extension Lock—CANCEL ALL".
- This operation can be performed only if the operator or manager has set the extension password of the corresponding extension. Refer to "2.1.7 System Feature Assignment—Extension Password Set (Manager only)".



Programming Manual References

[PT Programming]

- [108] Flash/Recall Mode for a Locked Extension
- [312] TRS—Extension Lock Class
- [601-603] TRS-COS—Day/Night/Lunch

[PC Programming]

- 9.1.11 Detail [1-10]—Extension—Flash/Recall Mode for a Locked Extension
- 9.2.2 Feature settings [2-2]—Remote Extension Lock
- 9.5.1 Class of Service (COS) [5-1]—Day, Night, Lunch
- 9.5.4 Emergency Number & Others [5-4]—Extension Lock Class

Feature Manual References

- 1.1.87 Operator/Manager Features
- 1.1.107 Remote Extension Lock

Operating Manual References

- 1.3.44 Extension Lock
- 2.1.7 System Feature Assignment—Extension Lock—CANCEL ALL
- 2.1.7 System Feature Assignment—Extension Password Set (Manager only)
- 3.1.3 Flexible Button Assignment
Create or edit an Extension Lock button.

2.1.7 System Feature Assignment

The operator or manager can set the following system features while in programming mode.

- Date & Time Set
- Extension Lock—CANCEL ALL
- Extension Password Set (Manager only)
- Live Call Screening (LCS) Password Control

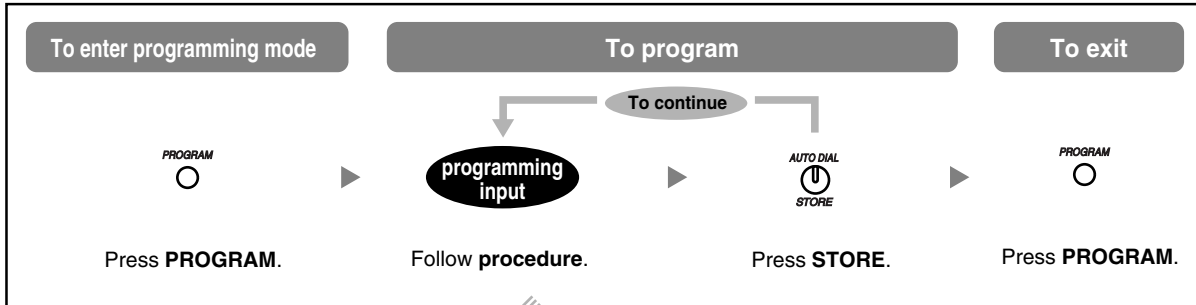

Setting	Procedure
Adjusting the current date and time (Date & Time Set)	0 date and time *1
Canceling Extension Lock; Call Log Display Lock, Incoming in the Personal Area; and Message Waiting for Another Extension Lock at all extensions (Extension Lock—CANCEL ALL)	8
Setting a password to each extension (Extension Password Set [Manager only])*2	7 manager password *3 + + + extension password + + *4 OR
Clearing the LCS Password (Live Call Screening [LCS] Password Control)	2 extension no.



- **WARNING**
There is a risk that fraudulent telephone calls will be made if a third party discovers your password.
The cost of such calls will be billed to the owner/renter of the PBX.
To protect the PBX from this kind of fraudulent use, we strongly recommend:
 - a) Keeping your password secret.
 - b) Selecting complex, random password that cannot be easily guessed.
 - c) Changing your password regularly.
- *1 Year (00–99), Month (01–12), Day (01–31), Day of the week (0–6: Sun–Sat), Hour (01–12), Minute (00–59), AM/PM (0/1)
- *2 The preprogrammed extension password can be used for the Walking COS feature and the Remote Extension Lock feature. Each extension's password must be unique.
- *3 The manager password is the password of the extension connected to extension jack 01. You can enter the system password instead of the manager password. For more details, refer to "[002] System Password" or "9.1.2 Main [1-2]" in the Programming Manual.
- *4 Extension numbers are displayed in the order of the jack numbers when you press the SP-PHONE (NEXT) or REDIAL (PREV) button.



Programming Manual References

[PT Programming]

- [002] System Password

[PC Programming]

- 9.1.2 Main [1-2]—System Password
- 9.2.3 PT personal settings [2-3]—Extension Password

Feature Manual References

- 1.1.87 Operator/Manager Features

Operating Manual References

- 1.3.19 Call Log Display Lock, Incoming in the Personal Area
- 1.3.44 Extension Lock
- 1.3.56 Live Call Screening (LCS) (Voice Mail APT Integration only)
- 1.3.62 Message Waiting for Another Extension Lock
- 1.3.90 Walking COS
- 2.1.6 Remote Extension Lock

2.1.8 The 301st Call Log, Incoming in the Common Area Treatment

The call log in the common area can store up to 300 call records. The operator or manager can select how new calls are treated when this call log is full; either the newest call is disregarded (i.e., not logged), or the oldest call whose information has been viewed is overwritten by the newest call. The Caller ID Selection—Common button lights when the call log in the common area is full.



No SLT

To disregard the newest call/overwrite the oldest call in the common area call log

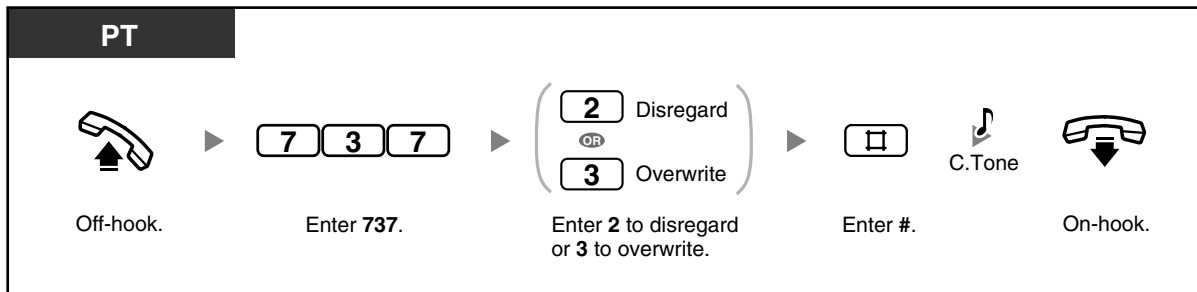

Programming Manual References

[PC Programming]

- 9.9.3 Call Log [9-3]—301st Call Log in Common Area

Feature Manual References

- 1.1.18 Call Log, Incoming
- 1.1.87 Operator/Manager Features

Operating Manual References

- 1.3.18 Call Log, Incoming
- 3.1.3 Flexible Button Assignment
Create or edit a Caller ID Selection—Common button.

2.1.9 Time Service

The PBX can be programmed to make and receive calls differently in each time service mode (day, night, and lunch).

The time service mode can be set to be changed manually (manual mode) or automatically at preprogrammed times (automatic mode) through system programming. Even if automatic mode has been selected, the operator or manager can change the current time service mode manually.



To change the time service mode manually

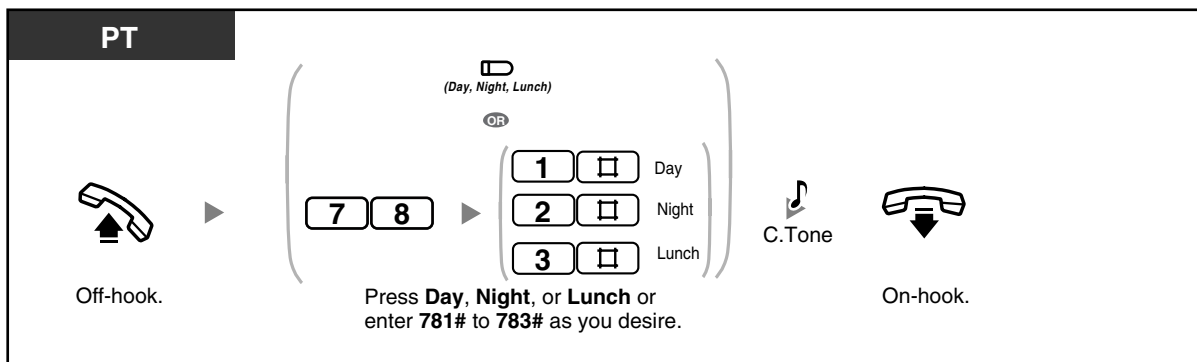

To return to automatic mode after changing the time service mode manually

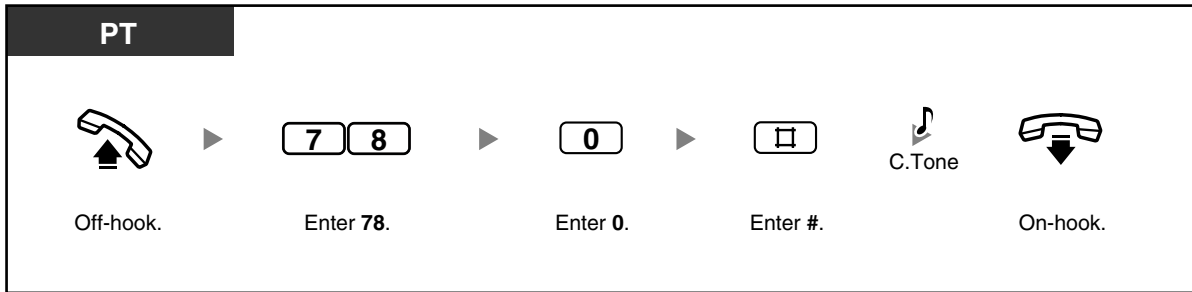

To confirm the current time service mode

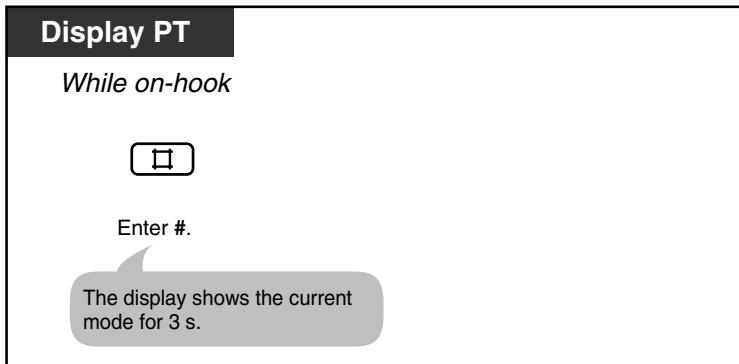

- The Day, Night, and Lunch button lights show the current status as follows:
Off: Not set
Red on: Set
- If lunch mode is set manually by entering "783#" while in automatic mode, the time service mode will not change automatically until you return to automatic mode by entering "780#". However, if day mode or night mode is set manually, the mode will still change automatically as programmed.
- It is not possible to cancel the current time service mode while in manual mode. Instead, enter the feature number corresponding to the time service mode you wish to set.



Programming Manual References

[PT Programming]

- [006] Time Service Switching Mode
- [007] Time Service Start Time
- [405-407] Flexible Outward Dialing—Day/Night/Lunch
- [408-410] Flexible Ringing—Day/Night/Lunch
- [411-413] Delayed Ringing—Day/Night/Lunch
- [414-416] CO Line Mode—Day/Night/Lunch
- [438-440] DISA IRNA to BV—Day/Night/Lunch
- [601-603] TRS-COS—Day/Night/Lunch
- [700-702] Doorphone Ringing—Day/Night/Lunch
- [703-705] Door Opener—Day/Night/Lunch

[PC Programming]

- 9.1.4 Time Service [1-4]
- 9.1.5 Time Service [1-4] Time Setting
- 9.3.1 Line Mode [3-1]—Mode of incoming CO calls—Day, Night, Lunch
- 9.3.2 Incoming / Outgoing [3-2]—Ringing for incoming CO calls—Day, Night, Lunch, Outgoing Call—Day, Night, Lunch
- 9.5.1 Class of Service (COS) [5-1]—Day, Night, Lunch
- 9.7.1 Ringing & Door Opener [7-1]—Doorphone 1–4—Day, Night, Lunch, Door Opener 1–4—Day, Night, Lunch
- 9.8.2 Others [8-2]—DISA IRNA to BV—Day, Night, Lunch

Feature Manual References

- 1.1.87 Operator/Manager Features
- 1.1.114 Time Service

Operating Manual References

- 3.1.3 Flexible Button Assignment
Create or edit a Day button, Night button, or Lunch button.

2.1.10 Timed Reminder, Remote (Wake-up Call)

The operator or manager can remotely set or cancel the Timed Reminder feature for any extension.



No SLT

To set

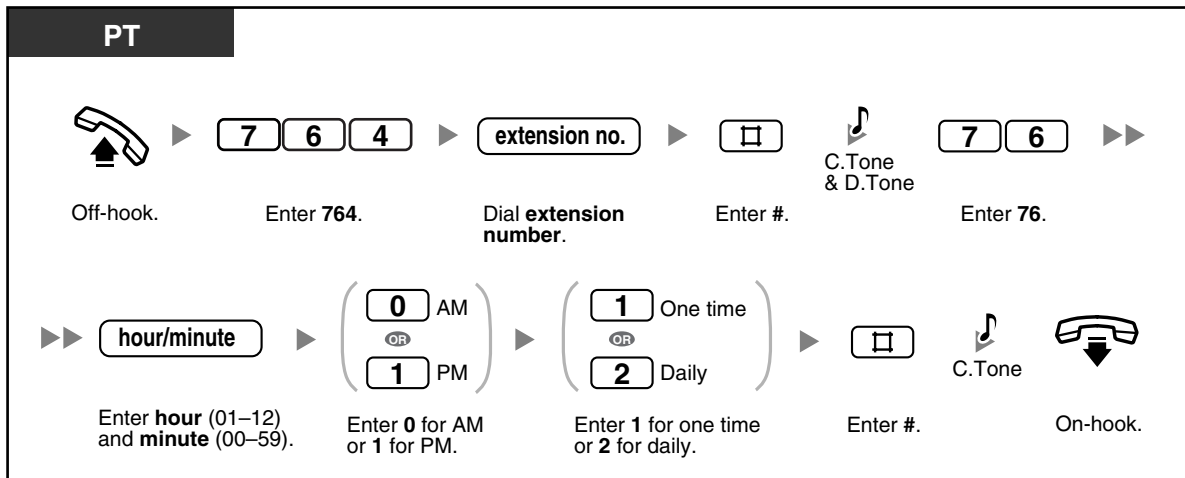

To cancel

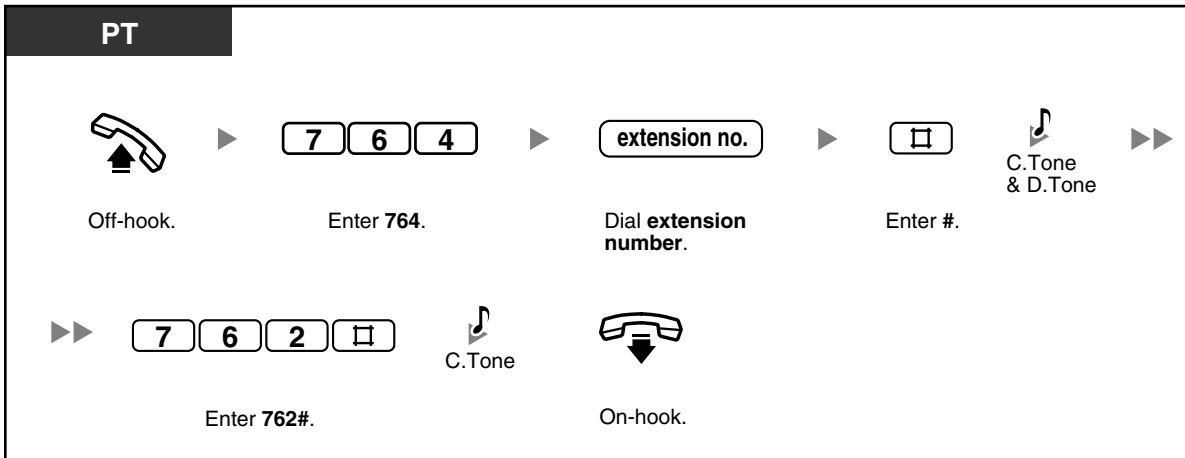

To confirm

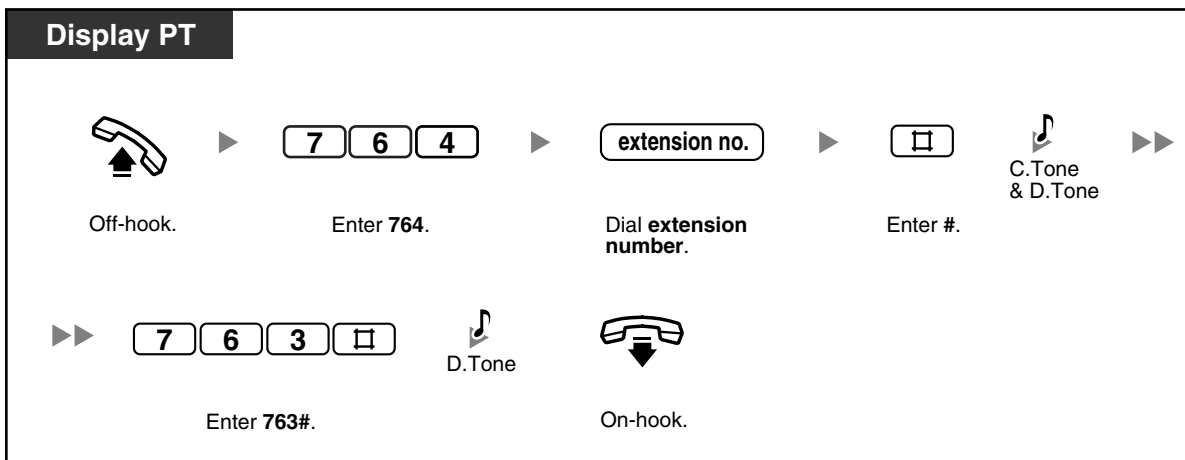



Programming Manual References

[PT Programming]

- [000] Date & Time

[PC Programming]

- 9.1.1 Date & Time [1-1]
- 9.2.2 Feature settings [2-2]—Timed Reminder

Feature Manual References

- 1.1.116 Timed Reminder, Remote

Operating Manual References

- 1.3.84 Timed Reminder

Section 3

Customizing Your Phone & PBX

This chapter shows you how to customize your proprietary telephone (PT) or PBX according to your needs.

3.1 Personal Programming

3.1.1 Programming Information

You can customize various features of your telephone, such as line preferences and customized buttons. Additionally, you can return all customized features to their default settings.



- Because certain settings are retained in your proprietary telephone (PT) (not in the PBX), before replacing or changing your PT, we recommend resetting all customized features to their default settings.
- The PROGRAM button is used to enter or exit programming mode.
- In order to program your extension, it must be idle, on-hook, and holding no calls.
- While you are programming your extension, it is treated as a busy extension.

3.1.2 Personal Feature Assignment

You can perform the following while in programming mode:

- Personal Programming
- Personal Programming Data Reset
- Self-extension Number Confirmation

◆◆ Personal Programming

The default settings are shown in bold letters. For later reference, place a check mark in the boxes below to indicate your customized setting.

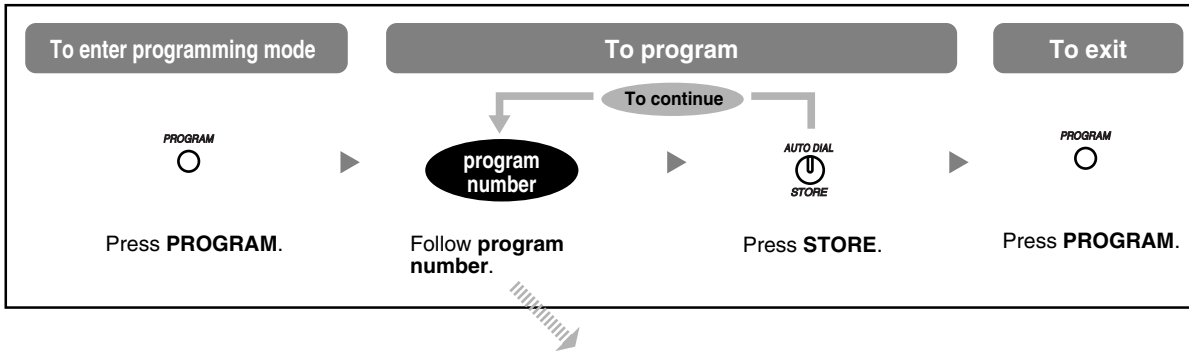

Item	Program Number	Setting
Which line do you prefer to seize when you go off-hook to make a call? (Line Preference—Outgoing)	1 1	<input type="checkbox"/> No line
	1 2	<input type="checkbox"/> An idle outside (CO) line
	1 3 + outside (CO) line no. (1–8)*	<input type="checkbox"/> An assigned outside (CO) line

Item	Program Number	Setting
Which line do you prefer to answer when you go off-hook? (Line Preference—Incoming)	<input type="text" value="2"/> <input type="text" value="1"/>	<input type="checkbox"/> No line
	<input type="text" value="2"/> <input type="text" value="2"/>	<input type="checkbox"/> A ringing line
	<input type="text" value="2"/> <input type="text" value="3"/> + outside (CO) line no. (1–8)*	<input type="checkbox"/> An assigned outside (CO) line
From which outside (CO) lines do you want to receive calls at your extension? (Outside (CO) Line Ringing Selection)	<input type="text" value="3"/> + outside (CO) line no. (1–8)*	<input type="checkbox"/> Ring—assigned outside (CO) lines
		<input type="checkbox"/> Ring—all outside (CO) lines
How do you prefer to receive intercom calls? (Alternate Receiving—Ring/Voice)	<input type="text" value="4"/> <input type="text" value="1"/>	<input type="checkbox"/> Ring (Tone Call)
	<input type="text" value="4"/> <input type="text" value="2"/>	<input type="checkbox"/> Directly—The party's voice is heard without ringing.
Which call waiting tone do you prefer for intercom/outside (CO) line calls? (Call Waiting Tone Type Selection)	<input type="text" value="5"/> <input type="text" value="1"/>	<input type="checkbox"/> Tone 1
	<input type="text" value="5"/> <input type="text" value="2"/>	<input type="checkbox"/> Tone 2
Which service do you prefer when a calling party is recording a message in your mailbox? (Live Call Screening [LCS] Mode Set)	<input type="checkbox"/> <input type="text" value="1"/> <input type="text" value="1"/>	<input type="checkbox"/> You can monitor the message through the telephone speaker. (Hands-free mode)
	<input type="checkbox"/> <input type="text" value="1"/> <input type="text" value="2"/>	<input type="checkbox"/> Only an alert tone is heard. (Private mode)



- * If there are only 3 lines in the PBX, outside (CO) line numbers 4 through 8 cannot be used.



- After the program number is entered, the program title and the selection are displayed.
- After you have changed a setting, one beep is heard. If the setting was invalid, 3 beeps are heard.



Programming Manual References

[PC Programming]

- 9.2.3 PT personal settings [2-3]—Line Preference—Outgoing, Line Preference—Incoming, CO Line Ringing Selection—CO1–8, Alternate Receiving, Call Waiting Tone Type, LCS Mode

Feature Manual References

- 1.1.27 Call Waiting
- 1.1.69 Intercom Call
- 1.1.75 Line Preference—Incoming
- 1.1.76 Line Preference—Outgoing
- 1.1.77 Live Call Screening (LCS) (Voice Mail APT Integration only)
- 1.1.90 Outside (CO) Line Ringing Selection

◆◆ Personal Programming Data Reset

You can reset the following features to their default settings.

This operation also cancels the AUTO ANS/MUTE status of both the Hands-free Answerback feature and the Room Monitor feature.

Feature	Default Setting
Line Preference—Outgoing	No line
Line Preference—Incoming	A ringing line
Outside (CO) Line Ringing Selection	Ring—all outside (CO) lines
Alternate Receiving—Ring/Voice	Ringing (Tone Call)
Call Waiting Tone Type Selection	Tone 1

To return features to default

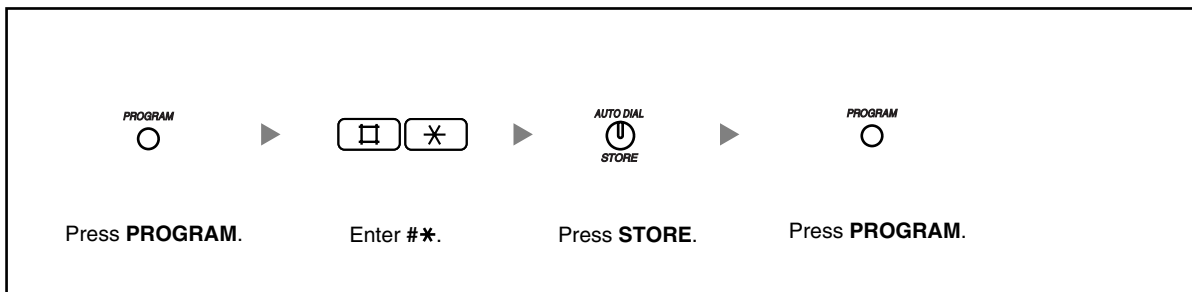

Feature Manual References

- 1.1.62 Hands-free Answerback
- 1.1.103 PT Programming
- 1.1.110 Room Monitor

◆◆ Self-extension Number Confirmation

You can confirm your jack and extension number.

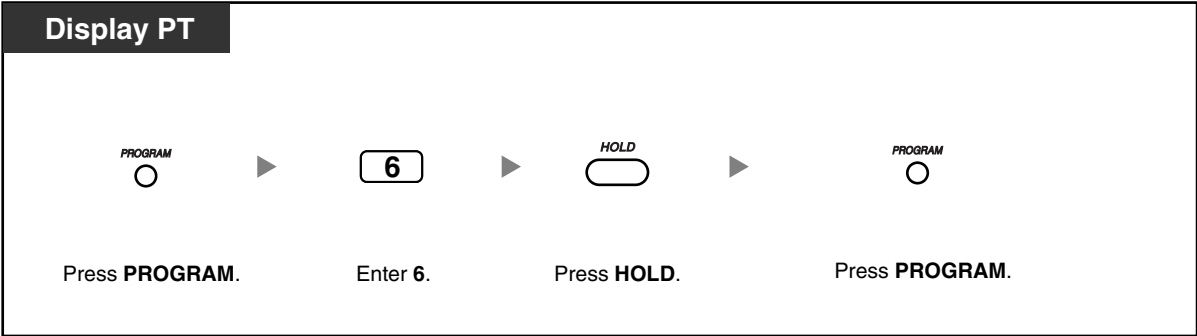

- You can also confirm your extension number by pressing the "*" key 2 times ("**") while on-hook. Every time you press the "*" key, the display switches between "date (month, day) and time", "date (month, day, year, day of the week)", and "extension number (and extension name if stored)".

- Feature Manual References**
- 1.1.43 Display Information

3.1.3 Flexible Button Assignment

You can customize the flexible CO buttons, Direct Station Selection (DSS) buttons, Programmable Feature (PF) buttons, and MESSAGE buttons on your proprietary telephone (PT) and DSS Console by assigning the following features to them. For example, if your telephone has more CO buttons than the number of outside (CO) lines connected to your PBX, you can customize unused CO buttons by assigning them to be One-touch Dialing buttons.

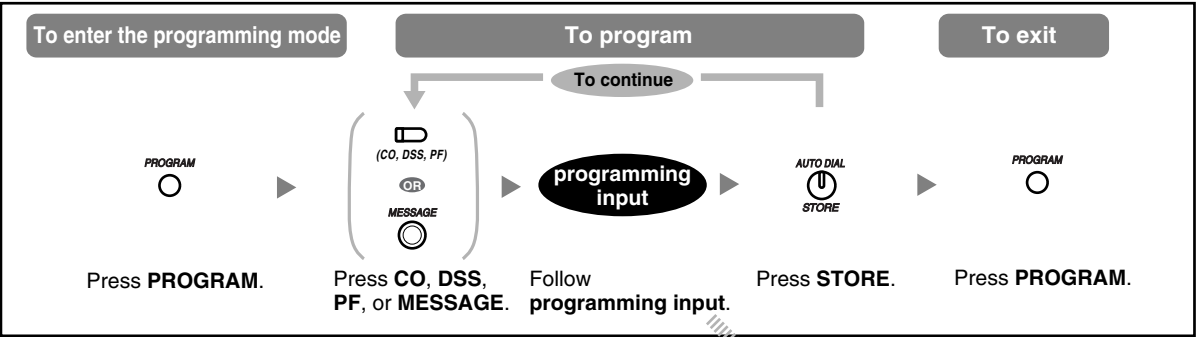

Button	Programmable Button				Programming Input
	CO	DSS	PF	MESSAGE	
Single-CO (S-CO)	✓				0 + outside (CO) line no. (1–8)*1
Group-CO (G-CO)	✓				☐ + outside (CO) line group no. (1–8)*1
Other-CO (O-CO)	✓				*
Direct Station Selection (DSS)	✓	✓		✓	1 + extension no.*1

3.1 Personal Programming

Button	Programmable Button				Programming Input
	CO	DSS	PF	MESSAGE	
One-touch Dialing*2	✓	✓	✓	✓	2 *3 + desired no.*1(max. 24 digits)
Conference	✓				3
Message*4				✓	3
FWD/DND (Call Forwarding/ Do Not Disturb)	✓				4
Day*5		✓			4
Save	✓				5
Night*5		✓			5
Caller ID Indication—Personal	✓				6
Lunch*5		✓			6
Caller ID Selection—Personal	✓				7
Extension Lock*5		✓			7 + extension no.*1
Log-in/Log-out	✓				8
2-way Record*6	✓	✓			9 0 + voice mail extension no.*1
2-way Transfer*6	✓	✓			9 1 + voice mail extension no.*1
Live Call Screening (LCS)*6	✓	✓			9 2
LCS Cancel*6	✓	✓			9 3
Voice Mail (VM) Transfer*6	✓	✓			9 4 + voice mail extension no.*1
Message for Another Extension	✓	✓			9 5 + extension no.*1
Caller ID Indication—Common	✓				9 6
Caller ID Selection—Common	✓				9 7



- *1 To erase an incorrect entry, press the TRANSFER (CLEAR) button. The TRANSFER button becomes the CLEAR button during programming.
- *2 Digits "0 through 9", "*", "#", PAUSE, and SECRET (INTERCOM) can be stored. If you do not want to display the stored number when making a call, press the SECRET (INTERCOM) button before and after the numbers you wish to conceal. If you store an outside party's number, you should first store an outside (CO) line access number (9, 81–88). If you need to enter an account code when making outside (CO) line calls, you can enter the Account Code feature number and specified account code after the outside (CO) line access number.
<Example>

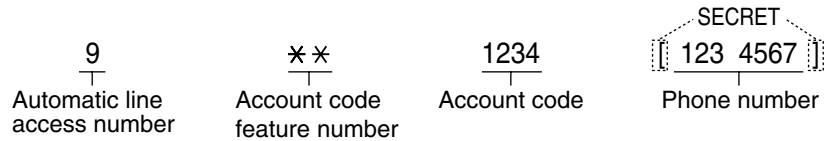

- *3 For a PF button, "2" need not be entered before the desired number.
- *4 Allows you to restore the Message Waiting feature to the Message button.
- *5 This button is only available for the operator/manager.
- *6 This button is used for Voice Mail Integration features.



- You can program DSS and PF buttons only from the paired PT.



Programming Manual References

[PC Programming]

- 9.2.4 Flexible Buttons [2-4]
- 9.2.8 DSS Console [2-5]—DSS buttons, PF buttons

Feature Manual References

- 1.1.61 Flexible Buttons

To confirm a button setting

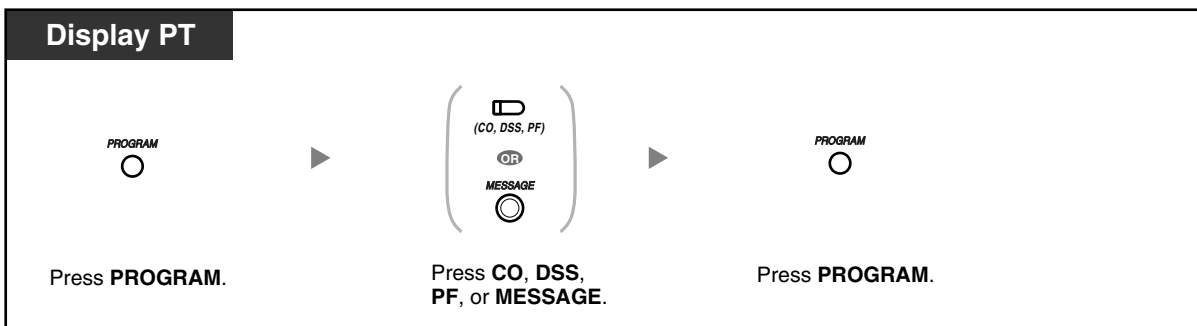

To clear a button setting

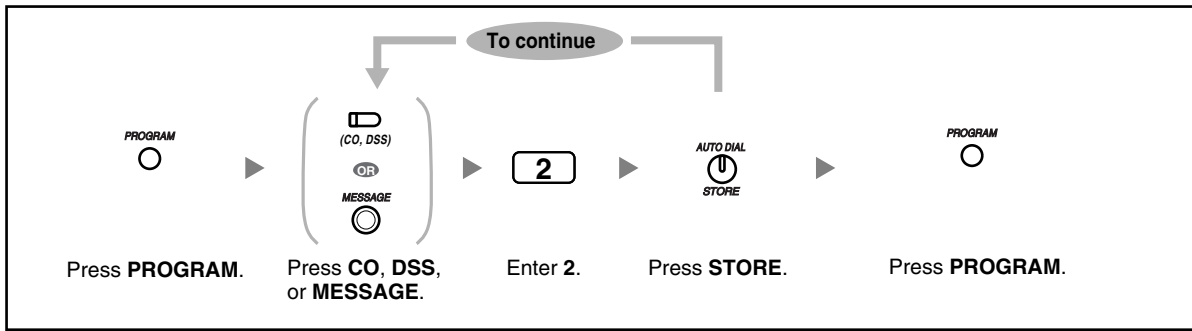

3.2 System Programming (Manager Programming)

3.2.1 Programming Information

You can change the default settings of your PBX according to your requirements.

Customizable programming items are shown below, with the program number in parentheses.

- [001] System Speed Dialing Number
- [011] System Speed Dialing Name
- [512] DISA Security Code
- [530] DISA Security Code Digits

Available Extension

The extension connected to extension jack 01

Required Telephone

A Panasonic proprietary telephone (PT) with a display (e.g., KX-T7731)

Manager Password

To enter programming mode, the manager password (the password of the extension connected to extension jack 01) is required. You can enter the system password instead of the manager password. Ask your administrator or dealer for the manager password or system password.













Conditions

In order to perform programming, your extension must be idle, on-hook, and holding no calls.

List

Before programming, decide the settings and write them down. Your notes will provide a useful record of the programming for future reference. Your dealer also has programming records that contain all dealer-performed system programming. If necessary, you can request copies of these records to confirm the available facilities and features.

◆◆ Icon Descriptions

Fixed Button (KX-T7700/KX-TA30800 series)	Function
	PREV (PREVIOUS)
	NEXT
	➡
	⬅, -
	-, ➡
	SECRET
	STORE
	PAUSE
	PROGRAM
	END
	SELECT
	FLASH
	CLEAR

◆◆ Procedure

The basic steps are shown below.

1. To enter programming mode

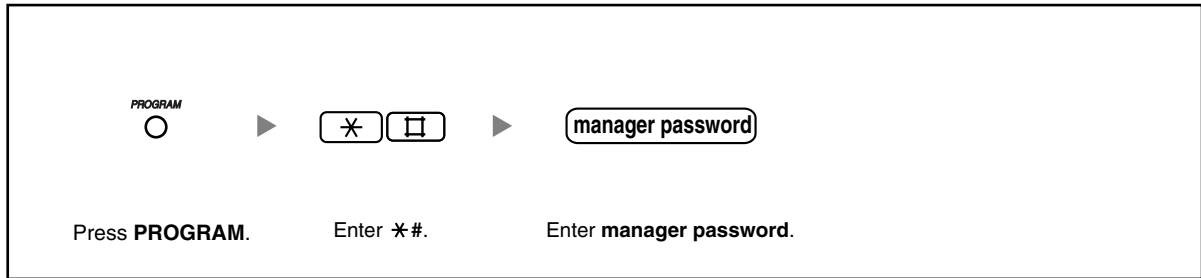

2. To program

You can enter each program number (3 digits).

3. To exit programming mode

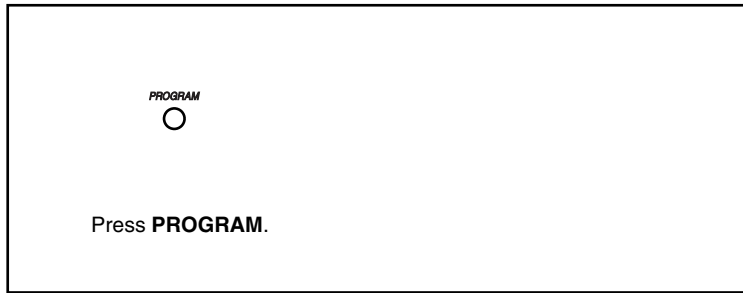

3.2.2 System Programming (Manager Programming)

◆◆ [001] System Speed Dialing Number

You can store frequently used phone numbers for convenient dialing.

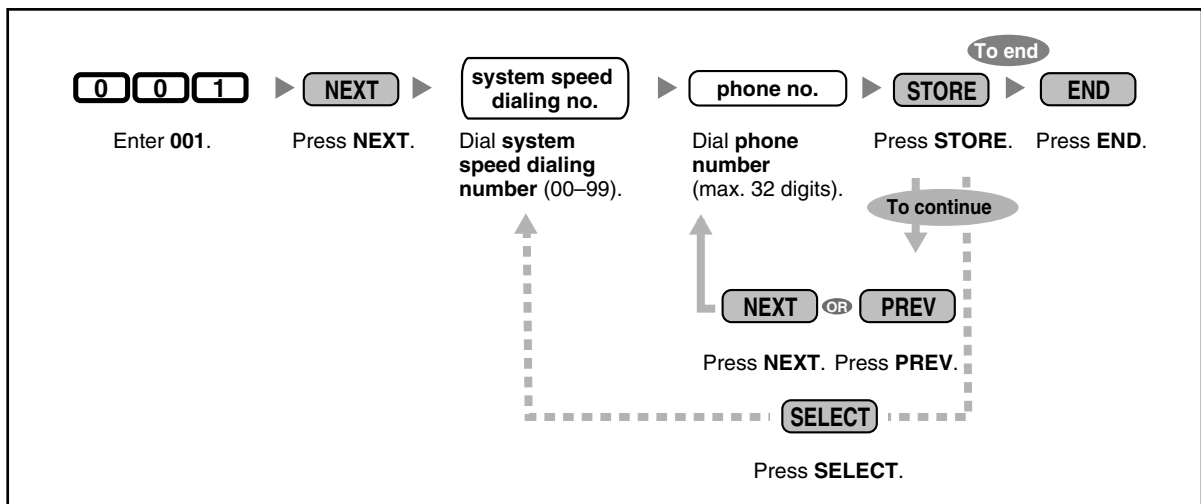



- If the desired number is more than 32 digits, divide the number and store it into more than one speed dialing number.
 - "*", "#", FLASH/RECALL, PAUSE, SECRET (INTERCOM), and "- (CONF)" can also be stored.
 - If you do not want to display the stored number when making a call, press the SECRET (INTERCOM) button before and after the numbers you wish to conceal.
- If you store an outside party's number, you should first store an outside (CO) line access number (9, 81–88).
- If you need to enter an account code when making outside (CO) line calls, you can enter the Account Code feature number and specified account code after the outside (CO) line access number.

<Example>

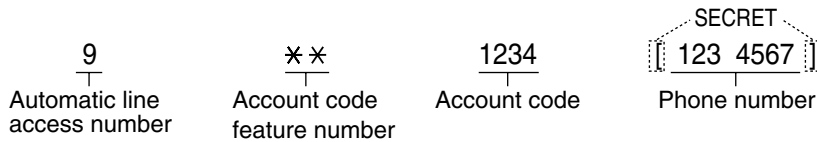

◆◆ [011] System Speed Dialing Name

You can store the name associated with each speed dialing number. These names are displayed when making calls using the System Speed Dialing feature. To enter characters, refer to "Entering Characters".

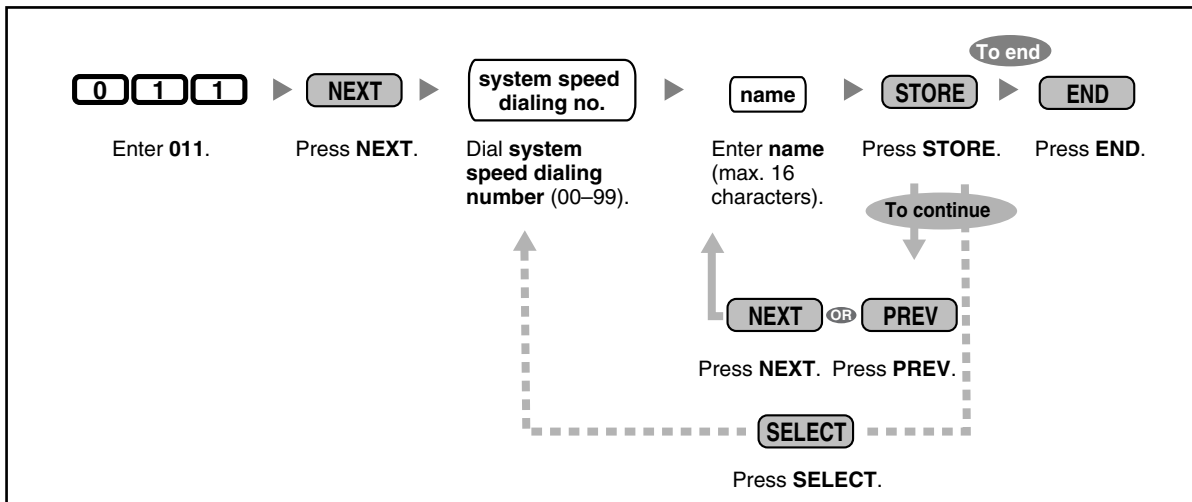

◆◆ [512] DISA Security Code

You can assign required Direct Inward System Access (DISA) security codes if "Trunk Security" or "All Security" is selected in [511] DISA Security Mode.

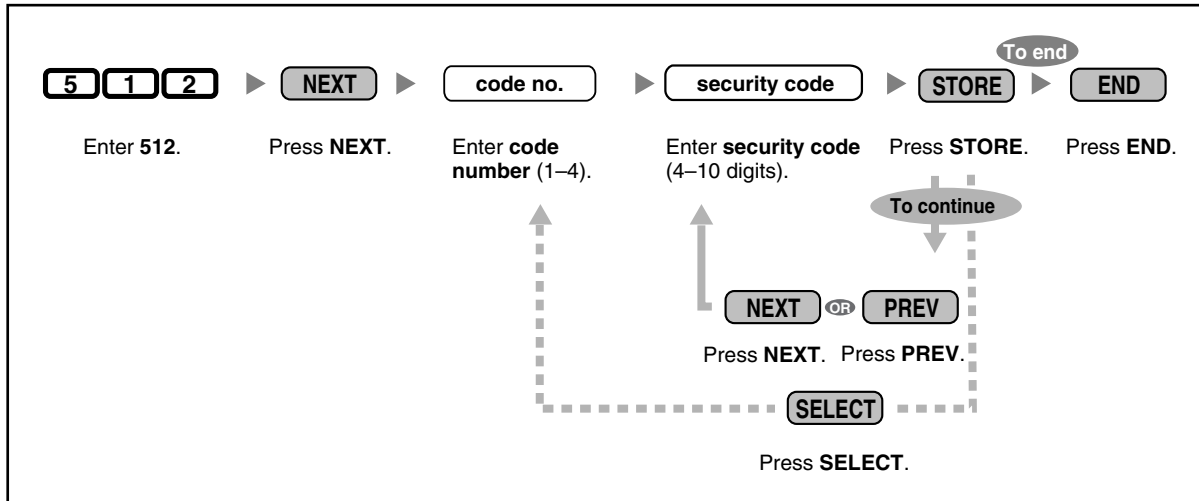

- **WARNING**
 There is a risk that fraudulent telephone calls will be made using the Outside-to-Outside (CO-to-CO) Line Call feature of DISA. The cost of such calls will be billed to the owner/renter of the PBX. To protect the PBX from this kind of fraudulent use, we strongly recommend:
 - a) Enabling DISA security (Trunk Security or All Security).
 - b) Keeping DISA security codes secret.
 - c) Selecting complex, random codes that cannot be easily guessed.
 - d) Changing codes regularly.
- Security code numbers (not security codes) are logged by Station Message Detail Recording (SMDR).
- The number of digits required for DISA security codes can be assigned in [530] DISA Security Code Digits.

◆◆ [530] DISA Security Code Digits

You can select the number of digits used for DISA security codes assigned in [512] DISA Security Code.

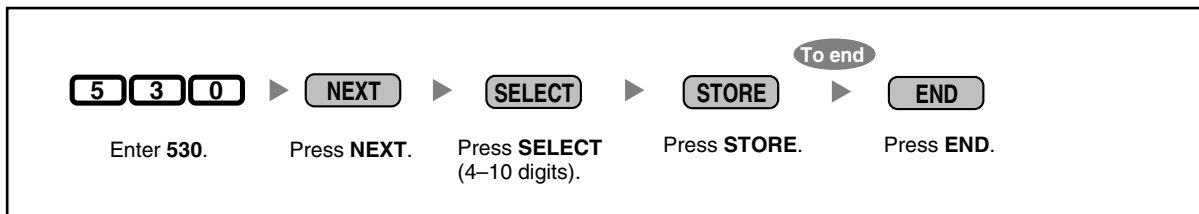

- When this setting is changed, all assigned DISA security codes are cleared.

◆◆ Entering Characters

You can enter the following characters. The tables below show you the characters available for each button.

Table 1 (Alphabet mode)/Table 2 (Numeral mode)

Buttons	Times								Buttons	Times	
	1	2	3	4	5	6	7	8		1	
1	!	?	"							1	1
2	A	B	C	a	b	c				2	2
3	D	E	F	d	e	f				3	3
4	G	H	I	g	h	i				4	4
5	J	K	L	j	k	l				5	5
6	M	N	O	m	n	o				6	6
7	P	Q	R	S	p	q	r	s		7	7
8	T	U	V	t	u	v				8	8
9	W	X	Y	Z	w	x	y	z		9	9
0	(Space)	.	,	'	:	;				0	0
*	/	+	-	=	<	>				*	*
□	\$	%	&	@	()				□	□

<Example> To enter "Ann",

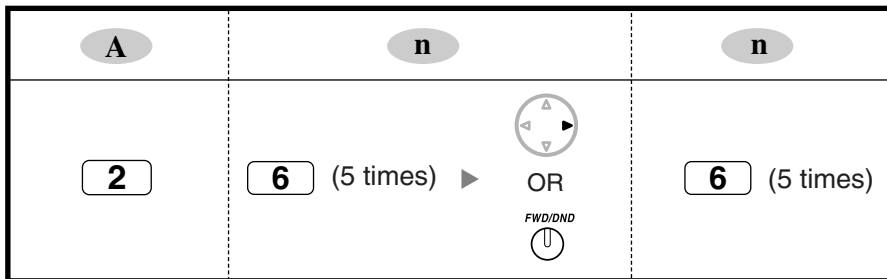

Notes

- To toggle between "Alphabet mode" and "Numeral mode", press SELECT.
- To move the cursor right, press **▶**.
- To delete all characters, press CLEAR. To delete a character, press **◀**.

Section 4











Appendix









This chapter provides Troubleshooting, the Feature Number Table and Tone List. Check the Troubleshooting section before consulting your dealer.

4.1 Troubleshooting

4.1.1 Troubleshooting

Problem	Remedy
I cannot make calls using the telephone.	<ul style="list-style-type: none"> • The telephone is locked. <ul style="list-style-type: none"> ➤ Unlock your telephone. (📞 1.3.44 Extension Lock, 2.1.6 Remote Extension Lock)
Some features do not function.	<ul style="list-style-type: none"> • System management may restrict certain features. <ul style="list-style-type: none"> ➤ Consult your manager or dealer.
I cannot make calls to other extensions using a proprietary telephone (PT).	<ul style="list-style-type: none"> • An idle or assigned outside (CO) line is being seized. The line seized when going off-hook was changed in personal settings. (📞 3.1.2 Personal Feature Assignment—Line Preference—Outgoing) <ul style="list-style-type: none"> ➤ If this setting has been changed, press the INTERCOM button after going off-hook, and then follow the instructions.
My new telephone does not function correctly.	<ul style="list-style-type: none"> • The previous extension's settings have not been cleared. <ul style="list-style-type: none"> ➤ Clear the settings and then program your desired settings again. (📞 1.3.43 Extension Feature Clear, 3.1.2 Personal Feature Assignment, 3.1.3 Flexible Button Assignment)
My PT does not have the button needed to perform a certain operation.	<ul style="list-style-type: none"> • Some models do not have certain feature buttons. <ul style="list-style-type: none"> ➤ Customize a flexible button to function as the desired button. (📞 3.1.3 Flexible Button Assignment) ➤ Enter the specified feature number instead of pressing the feature button. (📞 1.1.1 Before Operating a Telephone)
When I try to make an outside (CO) line call, I hear a reorder tone, or the display shows "Restricted".	<ul style="list-style-type: none"> • The telephone is locked. <ul style="list-style-type: none"> ➤ Unlock your telephone. (📞 1.3.44 Extension Lock, 2.1.6 Remote Extension Lock) • Toll Restriction (TRS) is activated. <ul style="list-style-type: none"> ➤ Consult your manager or dealer. (📞 1.3.85 Toll Restriction (TRS)) • An account code is required. (📞 1.3.90 Walking COS, 1.3.2 Account Code Entry)

Problem	Remedy
I cannot make an outside (CO) line call using a One-touch Dialing button or Speed Dialing.	<ul style="list-style-type: none"> • An outside (CO) line access number was not stored with the phone number. <ul style="list-style-type: none"> ➤ An outside (CO) line access number is required for outside (CO) line calls. ( 1.2.1 Making Calls, 3.1.3 Flexible Button Assignment)
During a conversation with an outside party, the call was disconnected.	<ul style="list-style-type: none"> • The specified time limit has run out. ( 1.3.27 Call Transfer—To Outside (CO) Line, 1.3.32 Conference, Unattended) <ul style="list-style-type: none"> ➤ Consult your manager or dealer about extending the time limit, if necessary.
The Redial feature does not function.	<ul style="list-style-type: none"> • The stored number is more than 64 digits long, or is an extension number. ( 1.3.78 Redial, Last Number, 1.3.79 Redial, Saved Number) <ul style="list-style-type: none"> ➤ Redialing can only be used with outside (CO) line numbers of 64 digits or less.
I cannot access computer services, telephone banking, etc.	<ul style="list-style-type: none"> • A tone signal is required and your outside (CO) line is set to "Pulse". ( 1.3.77 Pulse to Tone Conversion) <ul style="list-style-type: none"> ➤ Change the dialing mode.
Computer or fax machine communication was interrupted.	<ul style="list-style-type: none"> • An indication tone may have interrupted communication. ( 1.3.33 Data Line Security) <ul style="list-style-type: none"> ➤ Set your line to not receive signaling tones.
I cannot send a call waiting tone to the dialed extension.	<ul style="list-style-type: none"> • The other party has not set the Call Waiting feature. ( 1.3.8 Busy Station Signaling (BSS), 1.3.28 Call Waiting) • The other party has set Data Line Security. ( 1.3.33 Data Line Security)
I forgot my extension password.	<ul style="list-style-type: none"> • ➤ Ask your manager to assist you. ( 2.1.7 System Feature Assignment—Extension Password Set [Manager only])
Music started playing through the telephone's speaker.	<ul style="list-style-type: none"> • This is Background Music (BGM). ( 1.3.6 Background Music (BGM)) <ul style="list-style-type: none"> ➤ Turn off the music by entering "1" while on-hook. ➤ Ask your manager or dealer to set your extension not to play music when "1" is entered while on-hook.
I want to prevent a number that is stored in memory from being displayed when making a call.	<ul style="list-style-type: none"> • ➤ Conceal the number. ( 1.3.81 Secret Dialing)

Problem	Remedy
I want to confirm my extension number.	<ul style="list-style-type: none">  Confirm your extension number by pressing the "✖" key 2 times while on-hook, or through personal programming.  Your Extension Number in 1.1.1 Before Operating a Telephone, 3.1.2 Personal Feature Assignment—Self-extension Number Confirmation)
The date and/or time are not correct.	<ul style="list-style-type: none">  Ask your operator or manager to change the date or time. ( Date & Time Set in 2.1.7 System Feature Assignment)
The display is dim.	<ul style="list-style-type: none">  Change the display contrast level.  1.1.1 Before Operating a Telephone)
The MESSAGE/Message button light or Message/Ringer Lamp is lit.	<ul style="list-style-type: none"> There are 3 possible reasons: (1) Someone has left a message waiting indication for you, (2) Someone has left a Built-in Voice Message (BV) for you, or (3) Someone has left a Voice Mail message for you. Press the MESSAGE/Message button to call the party back or receive the message.
"Voice Msg Full" is displayed.	<ul style="list-style-type: none"> The maximum voice message recording time has been reached. <ul style="list-style-type: none">  Delete voice messages stored in your personal message area or in the common message area.  It may take about 10 seconds for the display to return to the idle status display even if the remaining recording time becomes 5 minutes or more.  1.3.7 Built-in Voice Message (BV))
A power failure has occurred.	<ul style="list-style-type: none"> When a power failure occurs... All functions of the PBX and Panasonic PTs stop. The following outside (CO) lines will be connected to the assigned single line telephones (SLTs): Outside (CO) line 1: extension jack 01 Outside (CO) line 4: extension jack 09 Outside (CO) line 7: extension jack 17 This allows outside (CO) line conversations between the specified SLTs and outside destinations. When the power is turned back on... Your PBX restarts with the stored data automatically. Memory is protected by a factory-provided lithium battery. There is no memory loss except for the data associated with Automatic Callback Busy, Redial, and Call Park.

4.2 Feature Number Table

4.2.1 Feature Number Table

The numbers listed below are the feature numbers to access the PBX features.

Feature (While a dial tone is heard)	Numbering	Additional Number
1.3.1 Absent Message		
– To set	75	1–6 (+ parameter) + #/0
– To cancel	75	0 + #/0
1.3.2 Account Code Entry	**/49	account code + outside phone no.
1.3.7 Built-in Voice Message (BV)		
– To record personal BV OGM	723	1 + #/0
– To play back personal BV OGM	723	2 + #/0
– To erase personal BV OGM	723	0 + #/0
– To set your calls to be forwarded to BV	71	1 (All Calls) or 2 (Busy/No Answer) + 725 + #/0
– To cancel your calls to be forwarded to BV	71	0 (Cancel) + #/0
– To leave a voice message using Direct Message	725	1 + extension no. + #/0
– To play back all voice messages in a voice message area	725	2 + #/0
– To erase all voice messages in a voice message area	725	0 + #/0
1.3.10 Call Forwarding (FWD)—All Calls	71	1 (All Calls) + extension no. + #/0
1.3.11 Call Forwarding (FWD)—Busy/No Answer	71	2 (Busy/No Answer) + extension no. + #/0
1.3.12 Call Forwarding (FWD)—Follow Me	71	5 (Follow Me) + your extension no. + #/0
1.3.13 Call Forwarding (FWD)—To Outside (CO) Line	71	3 (To Outside (CO) Line) + outside (CO) line access no. + outside phone no. + #
1.3.14 Call Forwarding (FWD)—CANCEL		
– To cancel at your extension	71	0 (Cancel) + #/0
– To cancel at another extension	71	8 (Follow Me Cancel) + your extension no. + #/0

4.2 Feature Number Table

Feature (While a dial tone is heard)	Numbering	Additional Number
1.3.17 Call Hold Retrieve		
– To retrieve an outside (CO) line call	53	no. (1–8) of outside (CO) line being held
– To retrieve an intercom call	5	extension no. that put the call on hold
1.3.18 Call Log, Incoming		
– To erase all caller information in the personal area	70*	#
– To disregard the newest call in the personal area	737	0 + #
– To overwrite the oldest call in the personal area	737	1 + #
– To set logging of caller information when answering a call	738	1 (Personal area) or 2 (Common area) + #/0
– To cancel logging of caller information when answering a call	738	0 (Cancel) + #/0
1.3.19 Call Log Display Lock, Incoming in the Personal Area		
– To lock	77	4-digit lock code 2 times + #
– To unlock	77	stored lock code + #
1.3.20 Call Park		
– To park a call	22	parking zone no. (0–9)
– To retrieve	52	stored parking zone no. (0–9)
1.3.21 Call Pickup, Directed	4	extension no.
1.3.22 Call Pickup, Group	40	
1.3.23 Call Pickup Deny		
– To prevent	72	1 + #/0
– To allow	72	0 + #/0
1.3.28 Call Waiting		
– To set for outside (CO) line calls	731	1 + #/0
– To cancel for outside (CO) line calls	731	0 + #/0
– To set for intercom calls/doorphone calls	732	1 + #/0
– To cancel for intercom calls/doorphone calls	732	0 + #/0
1.3.30 Call Waiting from the Telephone Company	6	
1.3.33 Data Line Security		
– To set	730	1 + #/0
– To cancel	730	0 + #/0

Feature (While a dial tone is heard)	Numbering	Additional Number
1.3.35 Do Not Disturb (DND)		
– To set	71	4 (Do Not Disturb [DND]) + #/0
– To cancel	71	0 (Cancel) + #/0
1.3.37 Door Open	55	door opener no. (1–4)
1.3.38 Doorphone Call	31	doorphone no. (1–4)
1.3.42 Executive Busy Override Deny		
– To prevent	733	0 + #/0
– To allow	733	1 + #/0
1.3.43 Extension Feature Clear	79	#/0
1.3.44 Extension Lock		
– To lock	77	4-digit lock code 2 times + #/0
– To unlock	77	stored lock code + #/0
1.3.45 External Feature Access (EFA)	6	
1.3.50 Hot Line		
– To store	74	2 + phone no. + #
– To set	74	1 + #/0
– To cancel	74	0 + #/0
1.3.51 Intercom Call	100–199	
1.3.53 Line Access, Automatic	9	outside phone no.
1.3.54 Line Access, Outside (CO) Line Group	8	outside (CO) line group no. (1–8) + outside phone no.
1.3.56 Live Call Screening (LCS) (Voice Mail APT Integration only)		
– To set the LCS password	77*	3-digit LCS password 2 times + #
– To cancel the LCS password	77*	stored LCS password + #
1.3.59 Log-in/Log-out		
– To log in	736	0 + #/0
– To log out	736	1 + #/0
1.3.60 Message Waiting		
– To leave	70	1 + extension no. + #/0
– To cancel	70	2 + extension no. + #/0
– To cancel all indications left at your extension	70	0 + #/0

4.2 Feature Number Table

Feature (While a dial tone is heard)	Numbering	Additional Number
1.3.61 Message Waiting for Another Extension – To cancel all indications left at another extension	70	3 + extension no. + #
1.3.62 Message Waiting for Another Extension Lock – To lock indications left at your extension – To unlock indications left at your extension	70 70	4-digit (4000–9999) lock code 2 times + #/0 stored lock code + #/0
1.3.65 Operator Call	0	
1.3.67 Paging—All Extensions	33	0
1.3.68 Paging—All Extensions & External	33	* or 9
1.3.69 Paging—External	34	
1.3.70 Paging—Group	33	extension group no. (1–8)
1.3.72 Paging Answer	43	
1.3.73 Paging Deny – To refuse – To accept	734 734	1 + # 0 + #
1.3.75 Personal Speed Dialing – To store – To dial – To confirm	2* 1*/# 3*	personal speed dialing no. (0–9) + phone no. + # personal speed dialing no. (0–9) personal speed dialing no. (0–9) + #
1.3.78 Redial, Last Number	80/##	
1.3.80 Room Monitor – To set – To cancel – To monitor through a doorphone	735 735 31	1 + # 0 + # doorphone no. (1–4)
1.3.82 System Speed Dialing	*	system speed dialing no. (00–99)
1.3.84 Timed Reminder – To set – To cancel – To confirm	76 76 76	hour/minute + 0 (AM)/1 (PM) + 1 (one time)/2 (daily) + #/0 2 + #/0 3 + #

Feature (While a dial tone is heard)	Numbering	Additional Number
1.3.88 Voice Mail Integration		
– To set your calls to be forwarded to a VPS	71	1 (All Calls) or 2 (Busy/No Answer) + voice mail extension no. + #/0
– To cancel your calls to be forwarded to a VPS	71	0 (Cancel) + #/0
– To listen to messages	784	#/0
1.3.90 Walking COS	7*	extension password + your extension no. + #/0
2.1.1 Call Log, Incoming in the Common Area—CLEAR ALL*	70**	#
2.1.2 Call Log Display Lock, Incoming in the Common Area*		
– To lock	77	4-digit lock code 2 times + #
– To unlock	77	stored lock code + #
2.1.3 Common BV Outgoing Messages*		
– To record	722	common BV outgoing message (OGM) no. (01–24) + 1 + #/0
– To play back	722	common BV OGM no. (01–24) + 2 + #/0
– To erase	722	common BV OGM no. (01–24) + 0 + #/0
2.1.8 The 301st Call Log, Incoming in the Common Area Treatment*		
– To disregard the newest call	737	2 + #
– To overwrite the oldest call	737	3 + #
2.1.9 Time Service*		
– To set (Day/Night/Lunch)	78	(1/2/3) + #
– To cancel	78	0 + #
2.1.10 Timed Reminder, Remote (Wake-up Call)*		
– To set	764	extension no. + # + 76 + hour/minute + 0 (AM)/1 (PM) + 1 (one time)/2 (daily) + #
– To cancel	764	extension no. + # + 76 + 2 + #
– To confirm	764	extension no. + # + 76 + 3 + #



- * This feature is only available for the operator/manager.

4.2 Feature Number Table

Feature (While a busy tone or DND tone is heard)	Numbering
1.3.5 Automatic Callback Busy (Camp-on)	6
1.3.8 Busy Station Signaling (BSS)	1
1.3.40 Executive Busy Override—Extension/1.3.36 Do Not Disturb (DND) Override	2

Feature (While dialing or talking)	Numbering
1.3.3 Alternate Calling—Ring/Voice	✖
1.3.24 Call Retrieving from a TAM (Telephone Answering Machine)	4*
1.3.31 Conference	3
1.3.37 Door Open	5
1.3.77 Pulse to Tone Conversion	✖#



- * Dial after dialing the TAM's extension number and hearing a busy tone.

Feature (When the extension is on-hook)	Numbering
1.3.6 Background Music (BGM) – To set/cancel	1
1.3.83 Time Service/2.1.9 Time Service – To confirm the current mode	#
3.1.2 Personal Feature Assignment—Self-extension Number Confirmation – To switch the display between "date (month, day) and time", "date (month, day, year, day of the week)", and "extension number (and extension name if stored)"	✖

4.3 Tone List

4.3.1 Tone List

While On-hook

Ring Tone Patterns

The following ring tone patterns can be assigned to incoming call types (outside (CO) line, intercom, or doorphone calls), or are fixed for certain features (Hold Recall [outside (CO) line calls/intercom calls], Timed Reminder, or Camp-on Recall).

Single

- Selectable: outside (CO) line calls, intercom calls, doorphone calls
- Fixed: Hold Recall [outside (CO) line calls]



Double

- Selectable: outside (CO) line calls, intercom calls, doorphone calls
- Fixed: Hold Recall [intercom calls]

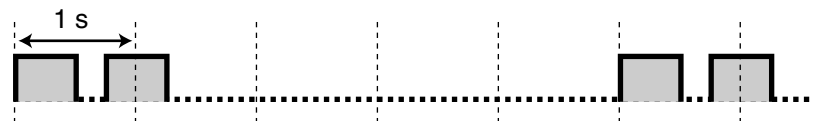

Triple

- Selectable: outside (CO) line calls, intercom calls, doorphone calls
- Fixed: Timed Reminder



S-Double

- Selectable: doorphone calls
- Fixed: Camp-on Recall



Note

The above tone patterns may vary depending on the system programming settings of your PBX.

Doorphone Chime Patterns

The following doorphone chime patterns can be assigned to each doorphone when doorbells and door chimes are connected to the PBX.

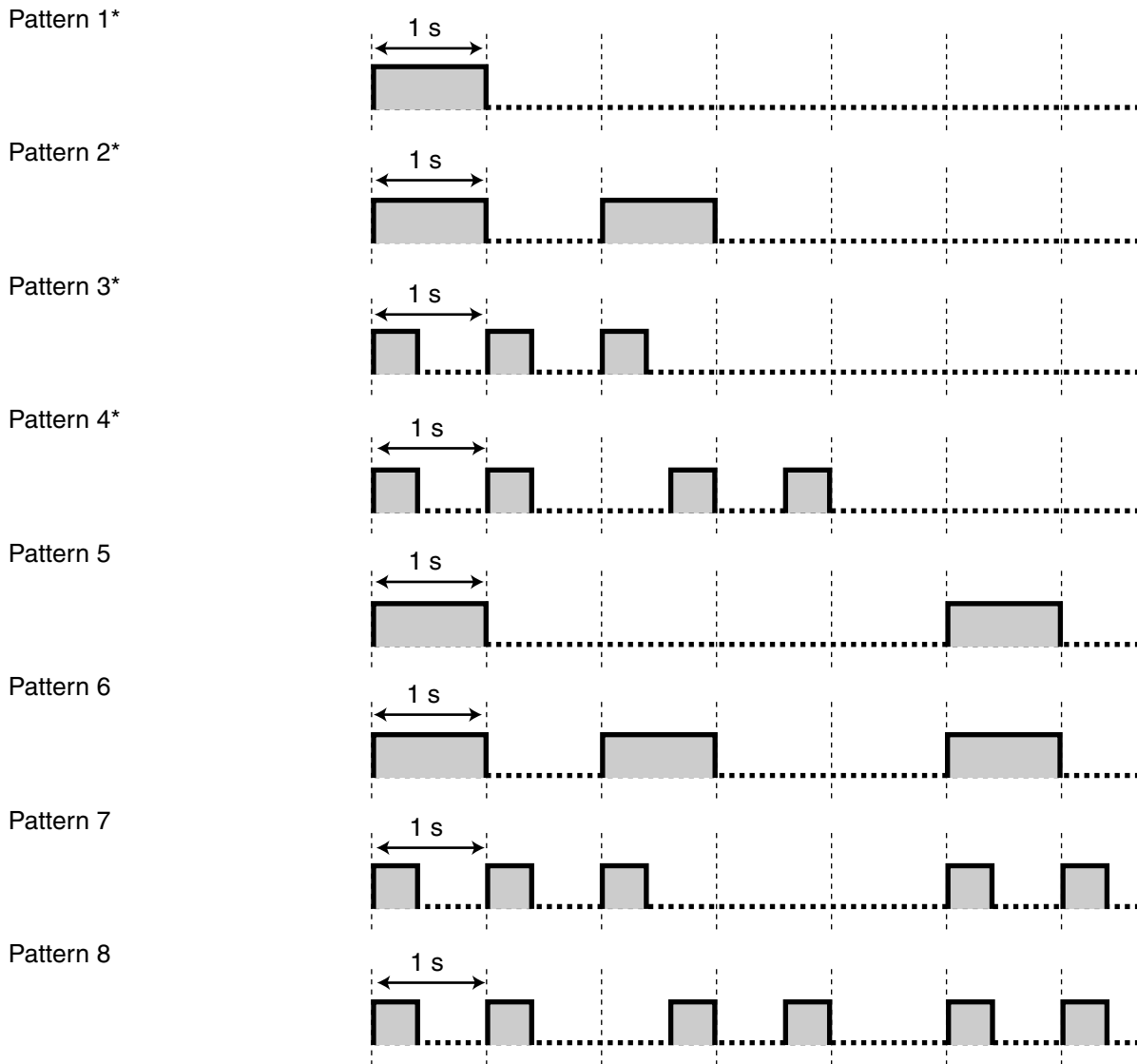

* Chime patterns 1 to 4 are played only one time during the doorphone ringing time.

When Going Off-hook

Dial Tones

Tone 1

Normal



Tone 2

Any of the following features is set:

- Absent Message
- Background Music (BGM) (proprietary telephone [PT] only)
- Call Forwarding (FWD)
- Call Pickup Deny
- Data Line Security
- Do Not Disturb (DND)
- Extension Lock
- Hot Line (single line telephone [SLT] only)
- Message Waiting (PT only)
- Remote Extension Lock
- Timed Reminder

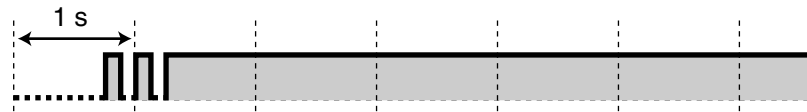

Tone 3

- When going off-hook with an SLT that has messages waiting
- When Account Code Entry is performed
- When answering a call from Timed Reminder



Tone 4

A new voice message has been recorded (Built-in Voice Message [BV]).



Tone 5

The remaining voice message recording time is less than 5 minutes or 125 voice messages have been recorded (Built-in Voice Message [BV]).

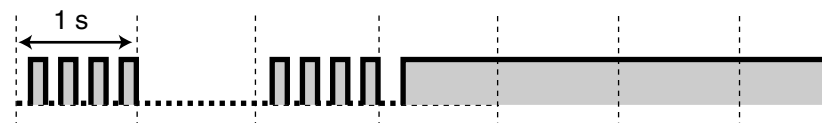

When Making Calls

Busy Tone

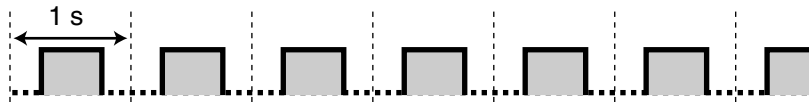

Reorder Tone

The outside (CO) line you tried to seize is not assigned or was denied.



Ringback Tones

Single (3-s interval)



Double (3-s interval)

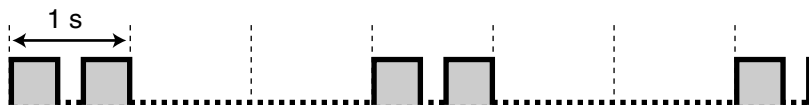

Single (5-s interval)

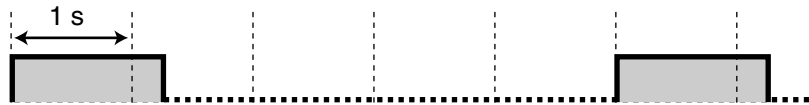

Double (5-s interval)

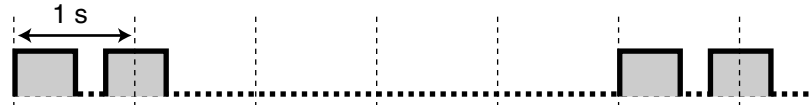

DND Tone

The dialed extension is refusing incoming calls.



While Off-hook

Indication Tones

Tone 1 (Call Waiting Tone)

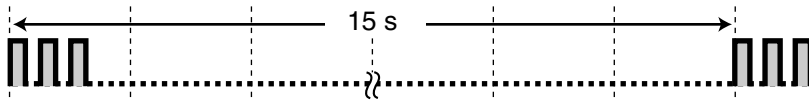

Tone 2 (Call Waiting Tone)

Single

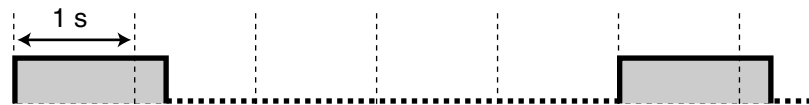

Double

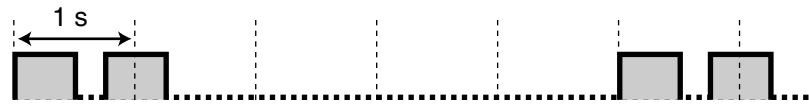

Triple

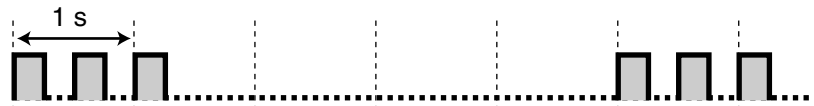
**Tone 3 (Hold Alarm Tone)**

A call has been on hold for longer than the specified time.

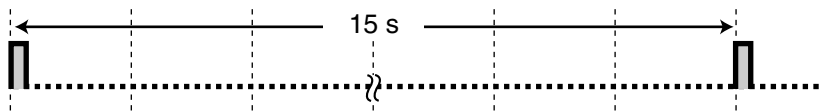

When Talking to an Outside Party

Warning Tone

This tone is sent 15 seconds before the specified time for disconnection.



When Setting the Features or Programming

Confirmation Tones**Tone 1**

The feature was set successfully, or the Extension Lock feature was set or canceled.

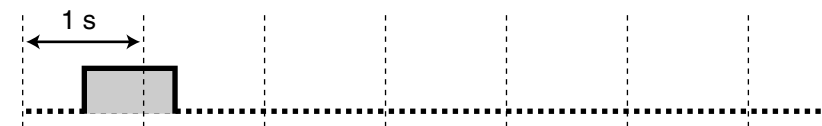
**Tone 2**

The new feature setting was the same as the previous setting, or certain features were successfully performed or accessed (e.g., Call Hold, Automatic Callback Busy).

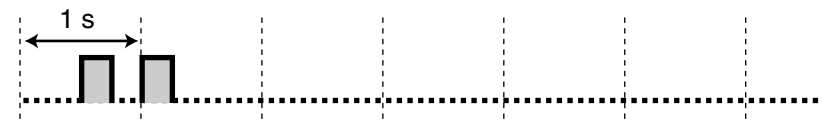
**Tone 3**

Before the following features activate:

- Retrieving a held call
- Picking up another call
- Establishing a conference call
- Paging/Answering a paging announcement



4.4 Revision History

4.4.1 Version 2.0

Changed Contents

- 1.1.1 Before Operating a Telephone
When You Use a Panasonic Proprietary Telephone
- 1.3.7 Built-in Voice Message (BV)
- 1.3.44 Extension Lock
- 2.1.3 Common BV Outgoing Messages
- 3.2.1 Programming Information
Icon Descriptions

Index

Symbols

[001] System Speed Dialing Number	163
[011] System Speed Dialing Name	164
[512] DISA Security Code	164
[530] DISA Security Code Digits	165

Numerics

2-way Record	18, 158
2-way Transfer	19, 158
3-level Automated Attendant	2

A

Absent Message	25, 171
Account Code Entry	26, 171
Alternate Calling—Ring/Voice	28, 176
Alternate Receiving—Ring/Voice	155
Answering, Direct Outside (CO) Line	28
Appendix	167
AUTO ANS (Auto Answer)/MUTE	17
AUTO DIAL/STORE	16
Automated Attendant (AA)	78
Automatic Callback Busy (Camp-on)	29
Automatic Callback Busy Cancel	30

B

Background Music (BGM)	30
Basic Operations	22
Before Operating a Telephone	14
BGM → Background Music (BGM)	30
BSS → Busy Station Signaling (BSS)	41
Built-in Voice Message (BV)	31
Busy Station Signaling (BSS)	41
Busy Tone	180
BV → Built-in Voice Message (BV)	31

C

Call Forwarding (FWD)	171
Call Forwarding (FWD)—All Calls	43
Call Forwarding (FWD)—Busy/No Answer	44
Call Forwarding (FWD)—CANCEL	46
Call Forwarding (FWD)—Follow Me	45
Call Forwarding (FWD)—SUMMARY	42
Call Forwarding (FWD)—To Outside (CO) Line	45
Call Hold	47
Call Hold Retrieve	49, 171
Call Hold, Exclusive	48
Call Log Display Lock, Incoming in the Common Area	136
Call Log Display Lock, Incoming in the Personal Area	56
Call Log, Incoming	51
Call Log, Incoming in the Common Area—CLEAR ALL	136
Call Park	57, 172
Call Park Retrieve	58
Call Pickup	172
Call Pickup Deny	60, 172
Call Pickup, Directed	59
Call Pickup, Group	59
Call Retrieving from a TAM (Telephone Answering Machine)	61
Call Splitting	61

Call Transfer—To Extension	63
Call Transfer—To Outside (CO) Line	64
Call Waiting	66, 172
Call Waiting Caller ID	68
Call Waiting from the Telephone Company	70
Call Waiting Tone	180
Call Waiting Tone Type Selection	155
Caller ID Indication—Common	18, 158
Caller ID Indication—Personal	18, 158
Caller ID Selection—Common	18, 158
Caller ID Selection—Personal	18, 158
CO	16
Common BV OGM	31, 137
Common BV Outgoing Messages	137
CONF	17
Conference	18, 71, 158
Conference, Unattended	73
Confirmation Tones	181
Connection Example	21
Customized Buttons	17
Customizing Your Phone & PBX	153

D

Data Line Security	74, 172
Date & Time Set	145
Day	18, 158
Dial Tones	179
Direct Inward System Access (DISA)	75
Direct Message	33
Direct Station Selection (DSS)	18, 157
DISA → Direct Inward System Access (DISA)	75
Display	14
DND → Do Not Disturb (DND)	79
DND Tone	180
Do Not Disturb (DND)	79, 172
Do Not Disturb (DND) Override	80
Door Open	81, 173
Doorphone Call	82
Doorphone Chime Patterns	178

E

Electronic Station Lockout → Extension Lock	88
Emergency Call	83
Entering Characters	166
Examples	15
Executive Busy Override Deny	87, 173
Executive Busy Override—Extension	84
Executive Busy Override—Outside (CO) Line	86
Extension Feature Clear	88
Extension Lock	18, 57, 88, 158
Extension Lock—CANCEL ALL	145
Extension Password	134, 144, 146
Extension Password Set	145
External Feature Access (EFA)	90

F

Feature Highlights	2
Feature Number Table	171
Feature Numbers	14

Fixed Buttons 16
 FLASH/RECALL 17
 Flash/Recall 91
 Flexible Button Assignment 157
 For Future Reference 7
 FWD → Call Forwarding (FWD) 42
 FWD/DND (Call Forwarding/Do Not Disturb) 17, 18, 158

G

Group-CO (G-CO) 18, 157

H

Handset/Headset Selection → Headset Operation 93
 Hands-free Answerback 92
 Hands-free Operation 92
 Headset Operation 93
 HOLD 17
 Hold Alarm Tone 181
 Hot Line 94
 How to Follow the Steps 20

I

Icon Descriptions 15, 162
 Incoming Call Log in the Common Area—CLEAR ALL 175
 Indication Tones 180
 INTERCOM 17
 Intercom Call 22, 95

L

LCS → Live Call Screening (LCS) 100
 LCS Cancel 19, 158
 LCS Password Control 145
 Line Access, Automatic 97
 Line Access, Outside (CO) Line 22
 Line Access, Outside (CO) Line Group 98
 Line Access, Outside (CO) Line—SUMMARY 96
 Line Access, S-CO Line 99
 Line Preference—Incoming 155
 Line Preference—Outgoing 154
 Live Call Screening (LCS) 19, 158
 Live Call Screening (LCS) (Voice Mail APT Integration only) 100
 Live Call Screening (LCS) Mode Set 155
 Local Carrier-based Voice Mail Service 103
 Lockout 104
 Log-in/Log-out 18, 105, 158, 173
 Lunch 18, 158

M

Making Calls 22
 Manager Password 146, 161
 Manager Programming (Manager only) 139
 MESSAGE 17
 Message 18, 158
 Message for Another Extension 18, 158
 Message Waiting 106, 173
 Message Waiting for Another Extension 109
 Message Waiting for Another Extension Lock 110
 Microphone Mute 111

MONITOR 17

N

Navigator Key 17
 Night 18, 158

O

One-touch Dialing 18, 111, 158
 One-touch Transfer 63
 Operation 13
 Operator Call 112
 Operator/Manager Operation 135
 Operator/Manager Service Features 136
 Other-CO (O-CO) 18, 157
 Outgoing Message (OGM) for DISA 75, 140
 Outside (CO) Line Ringing Selection 155

P

Paging and Transfer 116
 Paging Answer 117
 Paging Deny 117
 Paging—All Extensions 114
 Paging—All Extensions & External 114
 Paging—External 115
 Paging—Group 115
 Paging—SUMMARY 113
 Paralleled Telephone 118
 PAUSE 16
 Personal BV OGM 31, 33
 Personal Feature Assignment 154
 Personal Programming 154
 Personal Programming Data Reset 156
 Personal Speed Dialing 118
 Pickup Dialing → Hot Line 94
 Power Failure Transfer 120
 PROGRAM 17
 Programmable Feature (PF) 17
 Programming Information 154, 161
 Pulse to Tone Conversion 120, 176

R

Receiving Calls 24
 REDIAL 17
 Redial, Last Number 121
 Redial, Saved Number 121
 Remote Extension Lock 143
 Remote Station Lock Control → Remote Extension Lock 143
 Remote Timed Reminder (Wake-up Call) 175
 Reorder Tone 180
 Restrictions 15
 Revision History 182
 Ring Tone Patterns 177
 Ringback Tones 180
 Room Monitor 122

S

Save 18, 158
 Secret Dialing 124

Index

Self-extension Number Confirmation 156
Single-CO (S-CO) 18, 157
SP-PHONE 16
Station Feature Clear → Extension Feature Clear 88
Station Program Clear → Extension Feature Clear 88
Station Speed Dialing → Personal Speed Dialing 118
System Feature Assignment 145
System Password 146, 161
System Programming 161
System Programming (Manager Programming) 161, 163
System Speed Dialing 125

T

TAM → Telephone Answering Machine (TAM) 61
Telephone Answering Machine (TAM) 61
Telephone Features 25
The 301st Call Log, Incoming in the Common Area Treatment 146
Time Service 126, 147, 175
Timed Reminder 127, 174
Timed Reminder, Remote (Wake-up Call) 149
To select an idle outside (CO) line automatically 98
To select an idle unassigned outside (CO) line 98
Toll Restriction (TRS) 129
Toll Restriction (TRS) Override by Account Code 129
Tone 14
Tone List 177
TRANSFER 17
Troubleshooting 168
Two-way Recording in the VPS (Voice Mail APT Integration only) 129

U

Using a Navigator Key/Volume Key (depending on the type of your PT) 15

V

Version 2.0 182
VOICE CALL 17
Voice Mail (VM) Transfer 19, 158
Voice Mail Integration 130
Voice Mail Transfer (Voice Mail APT Integration only) 133
Volume Key 17

W

Walking COS 134, 175
Warning Tone 181
What Kind of Telephone Can Be Used? 14
When You Use a Panasonic Proprietary Telephone 16
Wireless Proprietary Telephones 3

Y

Your Extension Number 14

**Panasonic Consumer Electronics Company,
Division of Panasonic Corporation of North America**
One Panasonic Way, Secaucus, New Jersey 07094

Panasonic Puerto Rico, Inc.
San Gabriel Industrial Park, Ave. 65 de Infantería, Km. 9.5,
Carolina, Puerto Rico 00985

<http://www.panasonic.com/csd>

Copyright:

This material is copyrighted by Panasonic Communications Co., Ltd., and may be reproduced for internal use only. All other reproduction, in whole or in part, is prohibited without the written consent of Panasonic Communications Co., Ltd.

© 2005 Panasonic Communications Co., Ltd. All Rights Reserved.